

Installation - Operation Manual

Bead Baths 74300-706, 74300-714, 74300-720

Pictured on front cover, left to right: 74300-706 (6 liter bead bath), 74300-714 (14 liter bead bath), 74300-720 (20 liter bead bath)

These bead baths require the use of Lab Armor beads to function properly. The units are not watertight and cannot be used as water baths.



Warning: This product contains chemicals, including triglycidyl isocyanurate, known to the State of California to cause cancer as well as birth defects or other reproductive harm. For more information, go to www.P65Warnings.ca.gov.



¡Advertencia! Este producto contiene sustancias químicas, incluido el triglicidil isocianurato, que el Estado de California sabe que causa cáncer, así como defectos de nacimiento u otros daños reproductivos. Para obtener más información, visite www.P65Warnings.ca.gov.

Avertissement! Ce produit peut vous exposer à des produits chimiques, dont l'isocyanurate de triglycidyle, reconnu par l'État de Californie pour provoquer le cancer, des anomalies congénitales ou d'autres problèmes de reproduction. Pour plus d'informations, visitez le site www.P65Warnings.ca.gov.

Lab Armor Bead Baths

100 – 120 Voltage

Part Number (Manual): 4861829

Revised: May 14, 2019



Lab Armor is a brand of Sheldon Manufacturing, INC, an ISO 9001 certified manufacturer.



Safety Certifications

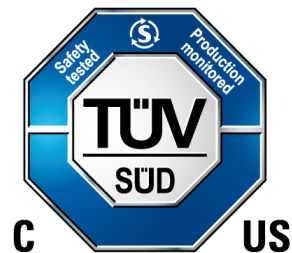

These units are CUE listed by TÜV SÜD as general purpose heated baths for professional, industrial, or educational use where the preparation or testing of materials is done at an ambient air pressure range of 22.14 – 31.3 inHg (75 – 106 kPa) and no flammable, volatile, or combustible materials are being heated.

CAN/CSA C22.2 No. 61010-1:2012
CAN/CSA C22.2 No. 61010-2-010 + R:2009
UL 61010-1:2004 + R:2005-07 + R:2008-10
UL 61010-1:2012
UL 61010A-2-010:2002
EN 61010-1:2010
EN 61010-2-010:2003

TABLE OF CONTENTS

INTRODUCTION	5
<i>Read this Manual.....</i>	5
<i>Safety Considerations and Requirements</i>	5
<i>Contacting Assistance</i>	6
<i>Engineering Improvements.....</i>	6
<i>Lab Armor Beads Required.....</i>	7
<i>Reference Sensor Device</i>	8
RECEIVING YOUR UNIT	9
<i>Inspect the Shipment.....</i>	9
<i>Orientation Images</i>	10
<i>Record the Data Plate Information.....</i>	14
INSTALLATION	15
<i>Installation Procedure Checklist</i>	15
<i>Required Ambient Conditions.....</i>	16
<i>Required Clearances.....</i>	16
<i>Power Source Requirements</i>	17
<i>Lifting and Handling</i>	18
<i>Leveling.....</i>	18
<i>Install the Bead Bath</i>	18
<i>Deionized and Distilled Water.....</i>	19
<i>Installation Cleaning and Disinfecting</i>	19
<i>Assemble the Bead Bath Cover.....</i>	20
GRAPHIC SYMBOLS	21
CONTROL OVERVIEW	23
OPERATION.....	25
<i>Theory of Operation</i>	25
<i>Put the Bead Bath into Operation</i>	26
<i>Fill With Lab Armor Beads</i>	27
<i>Set the Over Temperature Limit (OTL)</i>	29
<i>Loading Samples.....</i>	30
<i>Validating Application Protocols.....</i>	31
USER MAINTENANCE.....	33
<i>Cleaning and Disinfecting the Bath</i>	33
<i>Cleaning and Disinfecting Lab Armor Beads.....</i>	34
<i>Minimizing Contamination Exposure</i>	35
<i>Electrical Components</i>	35
<i>Calibrate the Temperature Display.....</i>	36
UNIT SPECIFICATIONS	41
<i>Weight.....</i>	41
<i>Dimensions.....</i>	41
<i>Capacity</i>	42
<i>Temperature</i>	42
<i>Power.....</i>	42
PARTS LIST.....	43
APPENDIX	45
<i>Tall Vessel Lid.....</i>	45

INTRODUCTION

Thank you for purchasing a Lab Armor bead bath. We know you have many choices in today's competitive marketplace when it comes to constant temperature equipment. We appreciate you choosing ours. We stand behind our products and will be here for you if you need us.

READ THIS MANUAL

Failure to follow the guidelines and instructions in this user manual may create a protection impairment by disabling or interfering with the unit safety features. This can result in injury or death.

Before using the unit, read the manual in its entirety to understand how to install, operate, and maintain the unit in a safe manner. Ensure all operators are given appropriate training before the unit begins service.

Keep this manual available for use by all operators.

SAFETY CONSIDERATIONS AND REQUIREMENTS

Follow basic safety precautions, including all national laws, regulations, and local ordinances in your area regarding the use of this unit. If you have any questions about local requirements, please contact the appropriate agencies.

SOPs

Because of the range of potential applications this unit can be used for, the operator or their supervisors must draw up a site-specific standard operating procedure (SOP) covering each application and associated safety guidelines. This SOP must be written and available to all operators in a language they understand.

Intended Applications and Locations

Lab Armor bead baths are intended for constant temperature, general purpose warming applications in professional, industrial, and educational environments. The units are not intended for use at hazardous or household locations.

Power

Your unit and its recommended accessories are designed and tested to meet strict safety requirements.

- The unit is designed to connect to a power source using the specific power cord type shipped with the unit.
- Always plug the unit power cord into a protective earth grounded electrical outlet conforming to national and local electrical codes. If the unit is not grounded properly, parts such as knobs and controls can conduct electricity and cause serious injury.
- Do not bend the power cord excessively, step on it, or place heavy objects on it.
- A damaged cord can be a shock or fire hazard. Never use a power cord if it is damaged or altered in any way.
- Use only approved accessories. Do not modify system components. Any alterations or modifications to your unit not explicitly authorized by the manufacturer can be dangerous and will void your warranty.

INTRODUCTION

CONTACTING ASSISTANCE

Phone hours for Sheldon Technical Support are 6 am – 4:30 pm Pacific Coast Time (west coast of the United States, UTC -8), Monday – Friday. Please have the following information ready when calling or emailing Technical Support: the **model number**, **serial number**, and **part number** (see page 14).

support@sheldonmfg.com
1-800-322-4897 extension 4
+1-(503) 640-3000 extension 4
FAX: +1-(503) 640-1366

Lab Armor
2010 Century Center Blvd, Suite 21
Irving, TX 75062
USA

ENGINEERING IMPROVEMENTS

Sheldon Manufacturing, INC. continually improves all of its products. As a result, engineering changes and improvements are made from time to time. Therefore, some changes, modifications, and improvements may not be covered in this manual. If your unit's operating characteristics or appearance differs from those described in this manual, please contact your Lab Armor dealer or customer service representative for assistance.

INTRODUCTION

LAB ARMOR BEADS REQUIRED

These aluminum-coated beads are designed to maximize thermal conductivity while still allowing ease of placement for samples.

The unit cannot operate as a water or oil bath.

Each bead bath unit requires a sufficient volume of beads to fill it to **1" (25 mm)** below the top of the bath. This level helps hold laboratory vessels in place while providing optimal temperature stability and uniformity.

Recommended Volume of Beads

Model	Bead Volume
74300-706	5 liters
74300-714	12 liters
74300-720	15 liters

See page 43 for ordering information.

Bead baths and traditional water baths have slight operational differences. See page 31 for a more detailed explanation.



INTRODUCTION

REFERENCE SENSOR DEVICE

Optional. **Must be purchased separately.**

A reference sensor device is required for calibrating the unit temperature display.

Reference devices must meet the following standards:

- Accurate to at least 0.1°C

The device should be regularly calibrated, preferably by a third party.

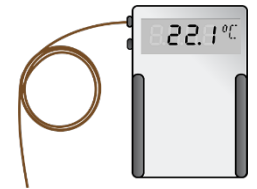

Temperature Reference

Temperature Probes

Use a digital device with a wire thermocouple probe. Select a thermocouple suitable for the application temperature you will be calibrating at.

Why Probes?

Reference readings taken from outside the tank using wire temperature probes avoid cover openings, which disrupt the unit temperature. Each disruption requires **a minimum 1-hour wait** to allow the temperature to re-stabilize before continuing.

No Alcohol or Mercury Thermometers

Alcohol thermometers do not have sufficient accuracy to conduct accurate temperature calibrations. **Never place a mercury thermometer in the tank.** Always use thermocouple probes.

RECEIVING YOUR UNIT

INSPECT THE SHIPMENT

- When a unit leaves the factory, safe delivery becomes the responsibility of the carrier.
- **Damage sustained during transit is not covered by the manufacturing defect warranty.**
- Save the shipping carton until you are certain the unit and its accessories function properly.

When you receive your unit, inspect it for concealed loss or damage to its interior and exterior. If you find any damage to the unit, **follow the carrier's procedure for claiming damage or loss.**

1. Carefully inspect the shipping carton for damage.
2. Report any damage to the carrier service that delivered the unit.
3. If the carton is not damaged, open the carton and remove the contents.
4. Inspect the unit for signs of damage. See the orientation depictions on the next pages as a reference.
5. The unit comes with an Installation and Operation Manual.
6. Verify that the correct number of accessory items has been included.
7. Carefully check all packaging for accessory items before discarding.

Included Accessories

Model	Gable Bath Cover	Power Cord
74300-706	1	1
		
74300-714	1	1
		
74300-720	1	1
		

RECEIVING

ORIENTATION IMAGES

74300-720 (20 Liter Bath)

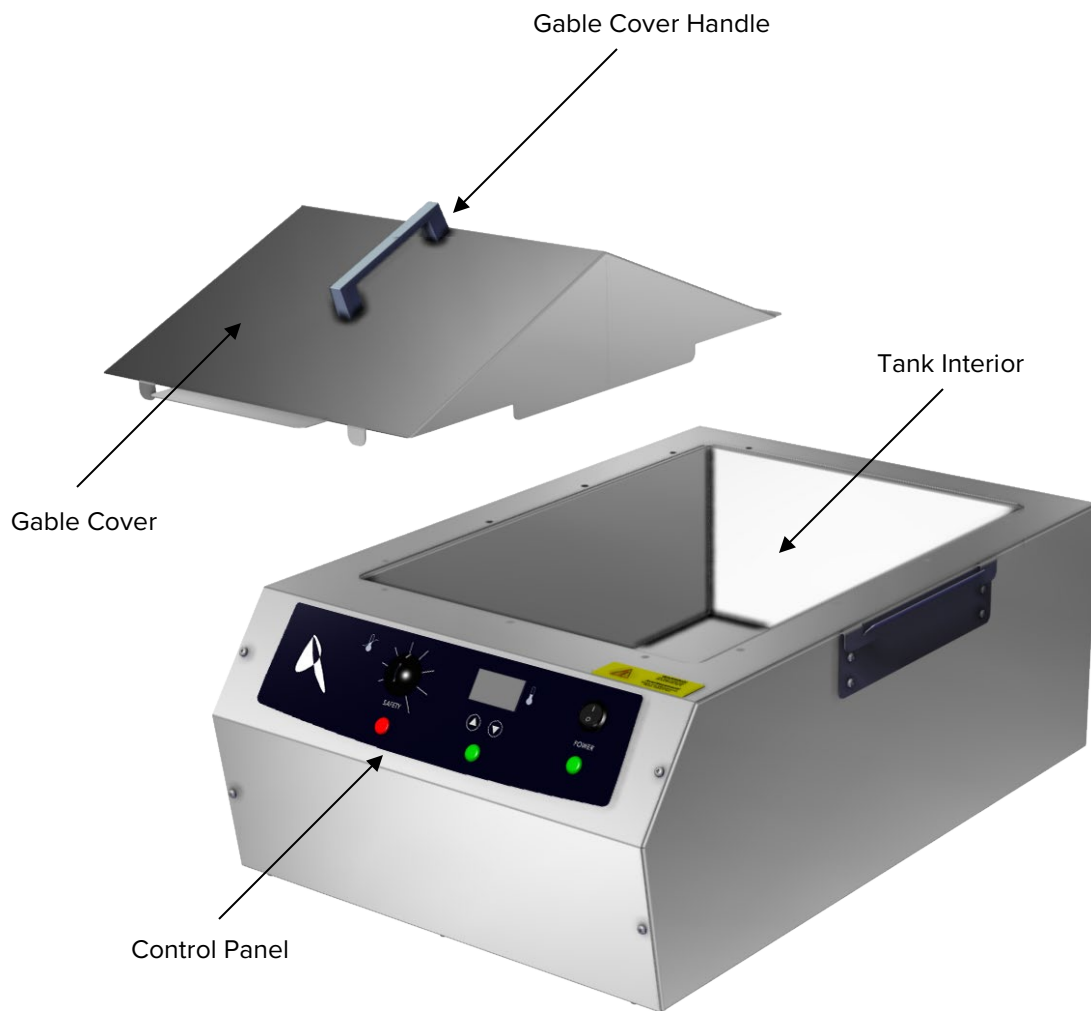

RECEIVING

74300-714 (14 Liter Bath)

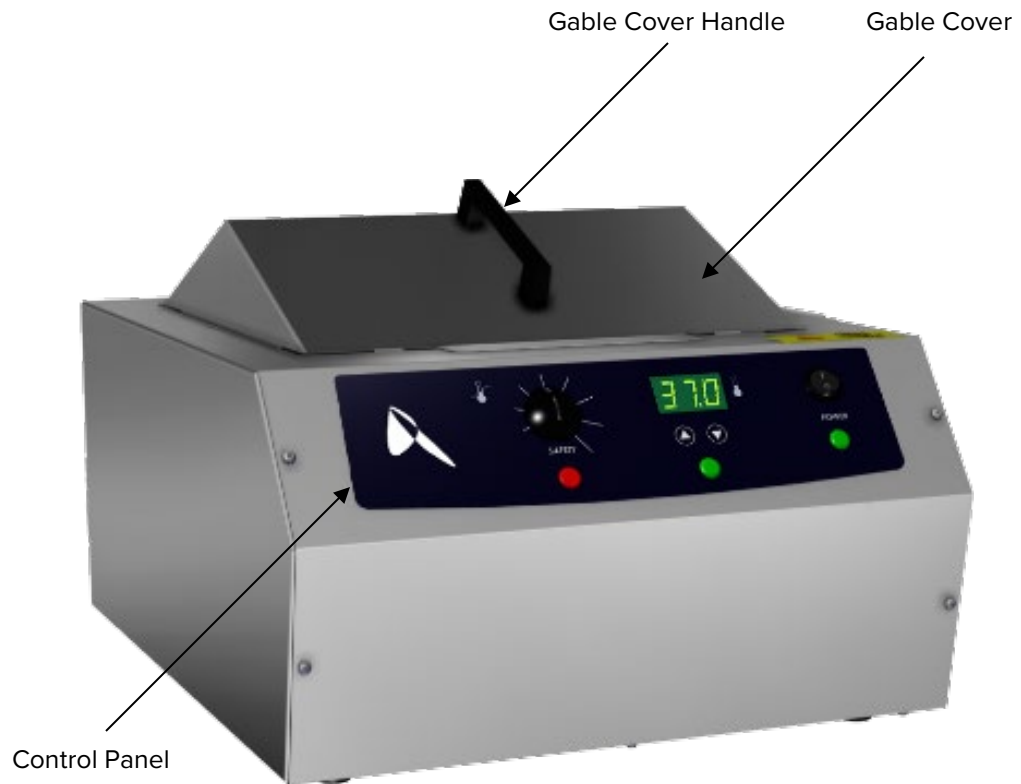

RECEIVING

74300-706 (6 Liter Bath)



RECEIVING

Back, All Units

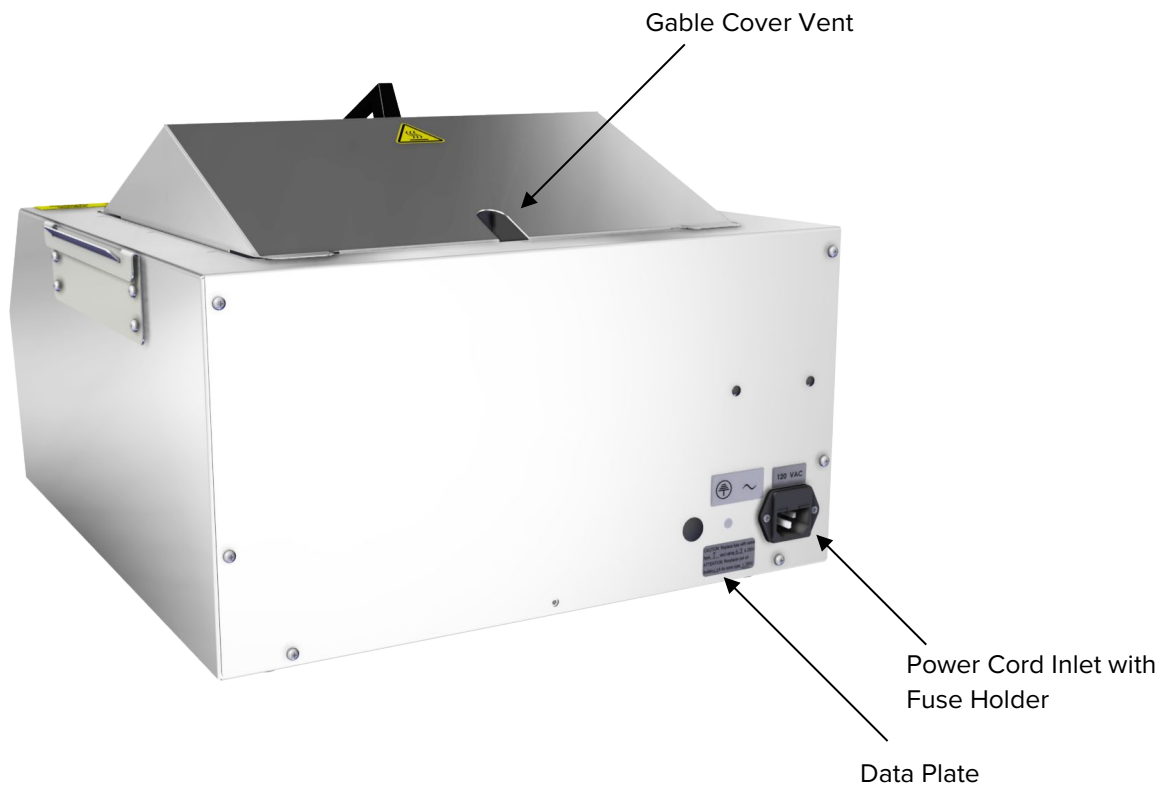

RECORD THE DATA PLATE INFORMATION

Record the unit **model number**, **serial number**, and **part number** below for future reference. Tech Support needs this information to provide accurate help during support calls and emails.

- The data plate is located on the rear of the unit, next to the power cord inlet.

MODEL NO:	
SERIAL NO:	
PART NO:	

INSTALLATION PROCEDURE CHECKLIST

For installing the unit in a new workspace location.

Pre-Installation

- ✓ Check that the required ambient conditions for the unit are met, page 16.
- ✓ Check that the spacing clearance requirements are met, page 16.
 - Unit dimensions may be found on page 41.
- ✓ Check that a suitable electrical outlet and power supply is present, page 17.

Install the bead bath in a suitable workspace location

- ✓ Review the lifting and handling instructions, page 18.
- ✓ Make sure the unit is level, page 18.
- ✓ Install the unit in its workspace location, page 18.

Set up the bead bath for use

- ✓ Clean and disinfect the unit and beads (recommended), page 19.
- ✓ Assemble the bead bath cover, page 20.

INSTALLATION

REQUIRED AMBIENT CONDITIONS

These units are built for use indoors at room temperatures between **15°C and 30°C (59°F and 86°F)**, at no greater than **80% Relative Humidity** (at 25°C / 77°F). Operating outside these conditions may adversely affect the unit temperature performance.

When selecting a location to install the unit, consider all environmental conditions that can adversely impact its temperature performance. These include:

- Proximity to ovens, autoclaves, or any other device producing significant radiant heat
- Heating and cooling vents or other sources of fast-moving air currents
- High-traffic areas
- Direct sunlight

REQUIRED CLEARANCES

These clearances are required to provide air flows for ventilation and cooling.

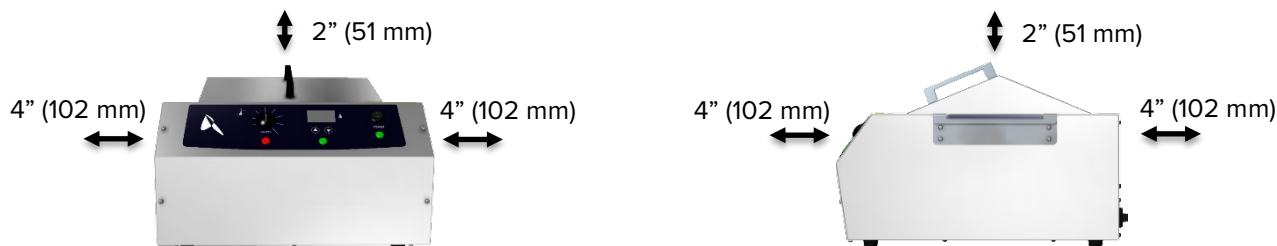

4 inches (102 mm) of clearance is required on the sides and back.

2 inches (51 mm) of headspace clearance is required between the top of the unit and any overhead partitions.

Ensure that there is sufficient overhead clearance for operators to remove the cover.

Note: If you are using a tall vessel lid, see the appendix on page 45 for overhead clearances.

INSTALLATION

POWER SOURCE REQUIREMENTS

When selecting a location for the unit, verify that each of the following requirements is satisfied:

Power Source

The power source must match the voltage and amperage requirements listed on the unit data plate. These units are intended for **100 – 120 volt 50/60 Hz** applications at the following amperages:

Model	Amperage
74300-706	3.0
74300-714	4.5
74300-720	6.0

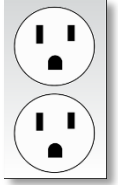

Standard
NEMA 5-15R
wall socket

- The wall power source must be protective earth grounded.
- **The unit may be damaged if the supplied voltage varies by more than 10% from the data plate rating.**
- Use a separate circuit to prevent loss of the unit due to overloading or circuit failure.
- **The recommended wall circuit breakers for these units are 15 amps.**
- The wall power source must conform to all national and local electrical codes.

Power Cord

The unit must be positioned so that all end-users can quickly unplug the power cord in the event of an emergency.



- Each unit is provided with a **110V, 15A, 9 ft 5 in (2.86 m) NEMA 5-15P** power cord.
- Always use this cord or an identical replacement.

Fuses

Each unit ships with a fuse installed in a fuse holder next to the power cord inlet.



- The fuse must be installed and intact for the unit to operate.
- Always find and fix the cause of a blown fuse prior to putting the unit back into operation.
- Fuse type:
 - 250V T6.3A, 5x20mm

INSTALLATION

LIFTING AND HANDLING

The unit is heavy. Use appropriate lifting devices that are sufficiently rated for these loads. Follow these guidelines when lifting the unit.

- Lift the unit only from its bottom surface.
- Handles and knobs are not adequate for lifting or stabilization.
- Restrain the unit completely while lifting or transporting so it cannot tip.
- Remove all moving parts, such as the cover and beads, during transfers to prevent shifting and damage.

LEVELING

The bead bath is equipped with non-adjustable rubber feet to raise it off the counter and prevent sliding. Ensure that the unit is on a flat and level surface, prior to placing the unit in operation.



INSTALL THE BEAD BATH

Install the unit in a workspace location that meets the criteria discussed in the previous entries of the Installation section.

INSTALLATION

DEIONIZED AND DISTILLED WATER

Do not use deionized water to clean the unit or cover, even if DI water is readily available in your laboratory.

- Use of deionized water may corrode metal surfaces and **voids the manufacturing warranty**.
- The manufacturer recommends the use of distilled water in the resistance range of 50K Ohm/cm to 1M Ohm/cm, or a conductivity range of 20.0 uS/cm to 1.0 uS/cm, for cleaning applications.

INSTALLATION CLEANING AND DISINFECTING

The manufacturer recommends cleaning and disinfecting the unit and accessories prior to installation.

Cleaning the Unit

- The unit was cleaned at the factory but may have been exposed to contaminants during shipping.
- Remove all wrappings and coverings from the gable cover prior to cleaning and assembly.
- Please see the [Cleaning and Disinfection](#) procedure on page 33 in the User Maintenance chapter for information on how to clean and disinfect without damaging the unit.
- **The unit is not watertight.** Do not fill the unit with water for cleaning.

Cleaning the Beads

- **Always wear gloves when handling beads to avoid contaminating the beads and bath.**
- Remove all packaging materials from beads prior to cleaning.
- See page 34 in the User Maintenance chapter for information on how to clean and disinfect Lab Armor beads.
- **Do not place beads in the unit at this time.**



INSTALLATION

ASSEMBLE THE BEAD BATH COVER

Attach and fasten the cover handle to the gable cover.

Note: The handle may come installed on the inside of the gable cover for shipping purposes. Uninstall the handle, then carry out the Assemble procedure.

1. Align the handle with the screw holes on the cover body.

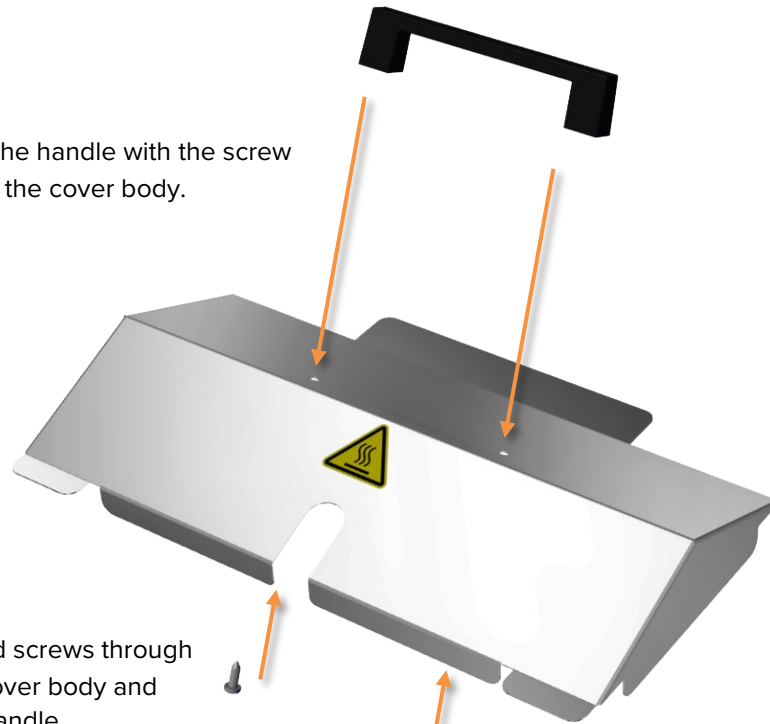

2. Insert the 2 included screws through the underside of the cover body and into the holes on the handle.



3. Use a **Phillips screwdriver** to tighten the screws until the handle is securely fastened. Do not overtighten.













Note: 74300-714 and 74300-720 covers have a vertical handle orientation.

Do not place the cover on the unit at this time.

GRAPHIC SYMBOLS

The unit is provided with graphic symbols on its exterior. These identify hazards and adjustable components as well as important notes in the user manual.

Symbol	Definition
	Consult the user manual Consulter le manuel d'utilisation
	Temperature display Indique l'affichage de la température
	Over Temperature Limit system Thermostat température limite contrôle haute
	AC Power Repère le courant alternatif
	I/ON O/OFF I indique que l'interrupteur est en position marche. O indique que le commutateur est en position d'arrêt.
	Adjusts UP and DOWN Ajuster le haut et vers le bas
	Potential shock hazard Risque de choc électrique
	Recycle the unit. Do not dispose of in a landfill. Recycler l'unité. Ne jetez pas dans une décharge
	Protective earth ground Terre électrique
	Caution hot surface Attention surface chaude
	Caution pinch hazard Attention risque de pincement



CONTROL OVERVIEW

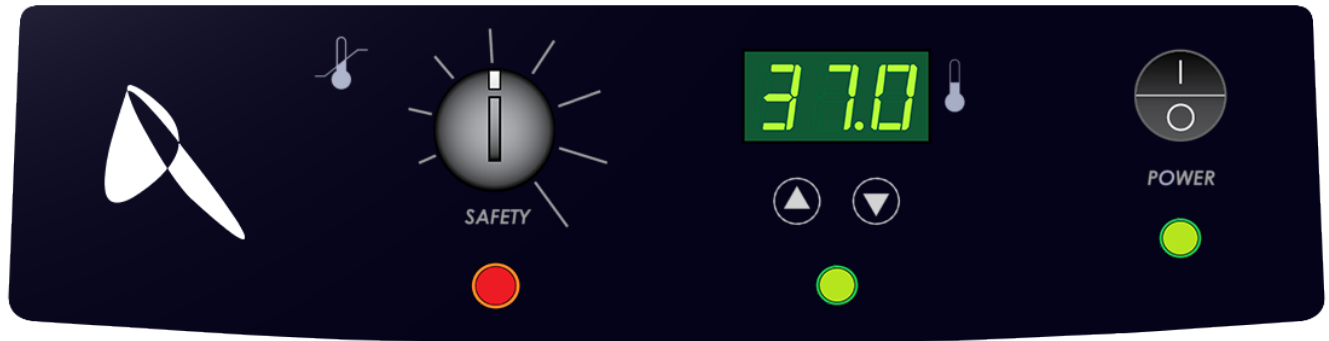

Control Panel

Over Temperature Limit Control (OTL)

This graduated dial, marked “Safety”, sets the mechanical heating cut off for the Over Temperature Limit system (OTL). The OTL helps prevent unchecked heating of the tank in the event of a hardware failure or external heat spike. For more details, please see the [Over Temperature Limit System](#) description in the Theory of Operations (page 25).

The red light illuminates when the OTL system cuts off heating to the tank by rerouting power away from the heating elements.



Power Switch

Power is supplied when the switch is in the (I) ON position.

The green Power light illuminates when the unit is turned on.

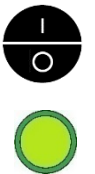

Temperature Control and Display

During normal operations, the display shows the current bead temperature, accurate to 0.1°C. The Up and Down arrow buttons are used to change display modes and input temperature set points or calibration adjustments. The display blinks continually while in set point or calibration adjustment modes, preceded by an “SP” for Set Point or “C O” for Calibration Offset.

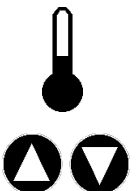

Heating Activated

The green light illuminates when the unit is calling for power to the heating elements.





THEORY OF OPERATION

Heating

When powered, the bead bath heats to and then maintains a user-selected temperature set point. The unit temperature controller senses the temperature of the beads via a solid-state probe located in the front, right corner of the tank. When the controller detects that the temperature of the beads has dropped below the target set point, it pulses power to the heating elements inside the bead bath walls and floor.



The bead bath uses Proportional – Integral – Derivative (PID) control to avoid significantly overshooting the set point. This means the rate of heating slows as the bead temperature approaches the target temperature. If the bead temperature is above the set point, the bead bath uses minimum heating to control the rate of cooling and avoid dipping below the set point.

Additionally, the PID loops optimize heating rates for the temperature environment around the bead bath. If the bead bath is operating in a cool room, it will increase the length of heating pulses to compensate. Likewise, when operating in a warm room the bead bath uses shorter pulses. If the ambient temperature conditions change significantly, there may be minor over or undershoots as the unit adapts.

Lab Armor bead baths rely on natural heat radiation for cooling. These units can achieve a low-end temperature of the ambient room temperature plus the internal waste heat of the bead bath.

The Over Temperature Limit System

The OTL is a mechanical heating cutoff, marked “Safety”, which operates independently of the unit microprocessor controller. The OTL helps safeguard the unit by preventing runaway heating in the event of hardware failures or a sudden external heat spike. If the bead temperature exceeds the OTL cutoff setting, the OTL routes power away from the heating elements. It will continue to do so as long as the bead temperature is higher than the present OTL cutoff setting. A red indicator light illuminates when the OTL is rerouting power.



The OTL is connected to a hydrostatic sensor probe located inside the tank and is intended to be set by the user to approximately 1°C above the target temperature set point. Failure to set the over temperature limit system voids the unit manufacturing defect warranty in the event of an over temperature event.

OPERATION

PUT THE BEAD BATH INTO OPERATION

Perform the following steps and procedures to put the unit into operation after installing it in a new workspace environment.

1. Plug in the Power Cord



Attach the power cord that came with the unit to the power inlet receptacle on the back of the unit.

Plug the power cord into the workspace electrical supply outlet.

2. Fill with Lab Armor Beads



Fill the tank to the appropriate level with beads.

- See page 27.

Place the cover on the bead bath.

3. Power the Bead Bath

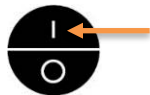

Place the unit **Power Switch** in the ON (I) position.

4. Set the Temperature Set Point

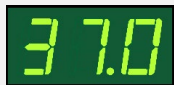

Set the Temperature Set Point to your application temperature.

- See page 28.

5. Allow the Bead Bath to heat for a minimum of 8 hours



Wait 8 Hours

Run the unit for at least 8 hours undisturbed (for example, overnight) with the cover on prior to:

- Setting the Over Temperature Limit.
- Loading samples.

This helps ensure a stable temperature environment.

6. Set the Over Temperature (Safety) Limit

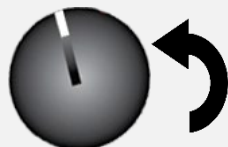

Set the Over Temperature Limit. See page 29.

- The unit must be heated **and stable** at your application temperature to perform this procedure.

The bead bath is now ready for use.

- You may **Load Samples**, page 30.

End of Procedure

OPERATION

FILL WITH LAB ARMOR BEADS

Warning: The tank is not watertight. Do not fill the tank with liquid. Use beads only.

Avertissement: Le réservoir n'est pas étanche. Ne remplissez pas le réservoir de liquide. Utilisez des perles seulement.



Reminder: The beads be should be cleaned and disinfected before filling the chamber. See page 34.

- Always wear gloves when handling beads to avoid contamination.



1. Fill the tank with beads. See page 7 for recommended volume of beads for your unit capacity.
 - a. Leave approximately **1 inch (25 mm)** of space from the top of the tank.

Note: The bead level will rise when samples are loaded.

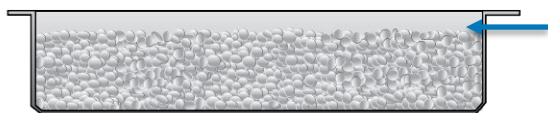

2. Place the gable cover on the bath.

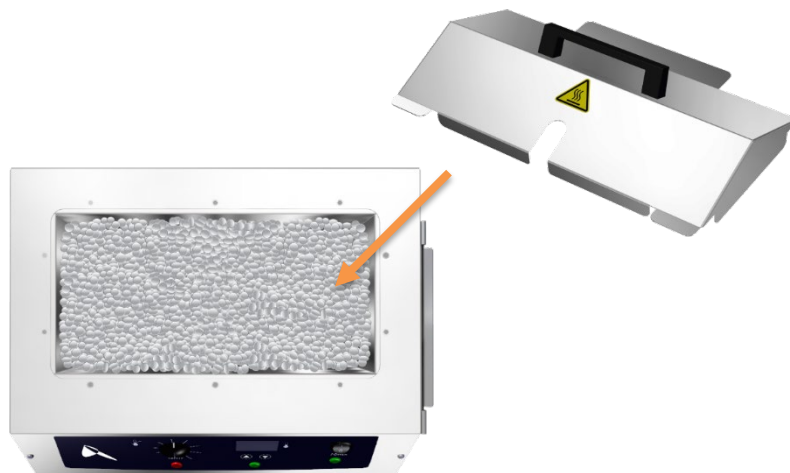

3. Turn on the unit. **Do not load samples at this time.**

End of Procedure

OPERATION



SET THE TEMPERATURE SET POINT

1. Set OTL (Safety) control to its maximum setting, if not already set to max

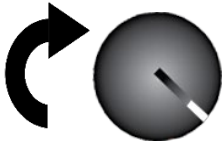

Turning the OTL all the way to the right (clockwise) prevents the heating cutoff system from interfering with this procedure.

2. Navigate to the Temperature Set Point Adjustment Mode



Push either button

Set Temperature °C



Set Point Adjustment Mode

Set Temperature °C



Initial Set Point

Note: The display will automatically exit the adjustment mode after 5 seconds of inactivity on the arrow keys, saving the last shown set point value.

3. Set the Temperature Set Point



Adjust



New Set Point

Adjust the set point to your application temperature using the **Up** and **Down** arrow buttons.

4. Wait 5 seconds after entering the Set Point



Wait 5 Seconds

Set Temperature °C



HEATING ACTIVATED

The display will stop flashing, and the set point is now saved in the controller. The unit will now automatically heat or passively cool to match your set point.

End of Procedure

OPERATION

Note: Test the OTL system at least once per year to verify its functionality. **Failure to set the OTL voids the manufacturing defect warranty if over temperature damage occurs.**

SET THE OVER TEMPERATURE LIMIT (OTL)

This procedure sets the Over Temperature Limit heating cutoff to approximately 1°C above the current bead temperature. **Perform this procedure when the unit has been running with no temperature fluctuations at your application temperature for at least 8 Hours.**



1. Set OTL (Safety) control to its maximum setting, if not already set to max.

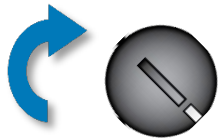

2. Turn the dial counterclockwise until the OTL light illuminates



3. Slowly turn the dial clockwise until the OTL light turns off

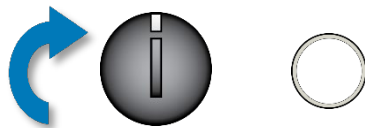

- The Over Temperature Limit is now set approximately 1°C above the current bead temperature.

4. Leave the OTL dial set just above the activation point



Optional: Turn the dial slightly to the left (counterclockwise)



- This sets the OTL cutoff threshold nearer to the current temperature of the tank chamber.

If the OTL sporadically activates after setting the control, turn the dial very slightly to the right (clockwise).

If the OTL continues activating, check for ambient sources of heat or cold that may be adversely impacting the unit temperature stability. If you find no sources of external or internal temperature fluctuations, contact Tech Support or your distributor for assistance.

End of procedure

OPERATION

LOADING SAMPLES

Load samples after the bath has run for at least **8 hours**.

1. Briefly stir the beads before loading samples. This helps ensure temperature uniformity.
 - Always use a stirring rod to avoid contamination. Avoid using a metal rod to prevent scratching the tank and beads.

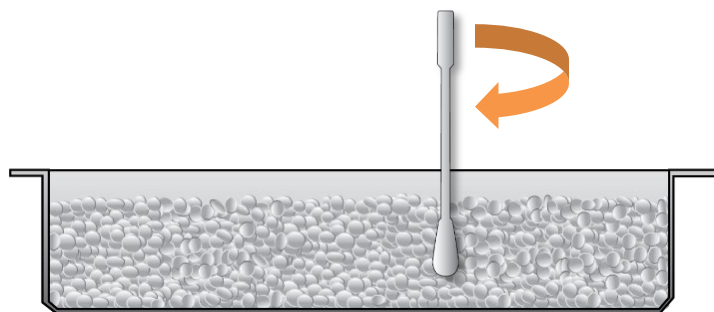

2. Load samples in the tank. Ensure that the combined volume of samples and beads does not cause the tank to overflow.
 - Samples must be completely surrounded by beads without touching the walls and floor of the tank to avoid uneven heating.

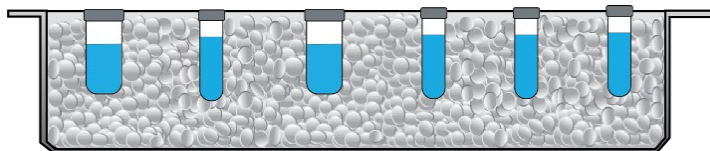

3. Place the gable cover on the bead bath.
 - Ensure that the cover sits level.



VALIDATING APPLICATION PROTOCOLS

All water bath application protocols should be validated when switching to bead baths. Applications involving large or frozen vessels may take 2 – 3 times longer to achieve the target set point than in a traditional water bath due to the high thermal stability of the beads.

Bringing the temperature of frozen samples up to 4°C before placing in the bead bath can help optimize heat up times.

Thawing

When using bead baths for thawing applications, periodically relocate cold vessels within the tank to ensure optimal temperature uniformity.

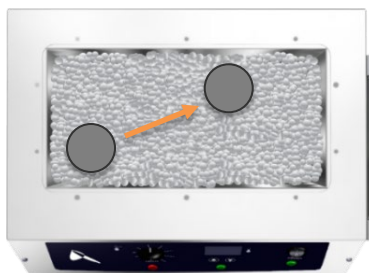

Note: Do not place frozen vessels adjacent to the temperature probe located in the front, right corner of the tank. This will cause the probe to register the chilled temperature of the beads immediately surrounding the frozen samples, potentially causing the bead bath to raise the overall bath temperature.

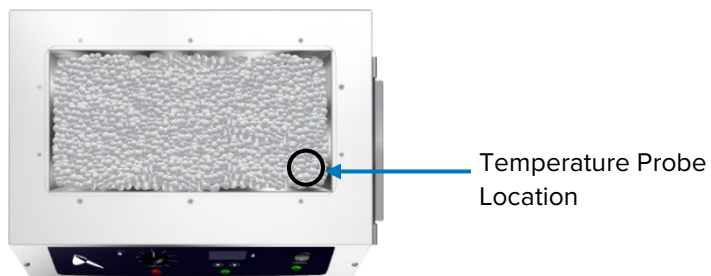



USER MAINTENANCE

Warning: Disconnect the unit from its power supply prior to performing maintenance or services.

Avertissement: Débranchez cet appareil de son alimentation électrique avant d'effectuer la maintenance ou les services.



CLEANING AND DISINFECTING THE BATH

If a hazardous material or substance has spilled in the tank, immediately initiate your site Hazardous Material Spill Containment protocol. Contact your local Site Safety Officer and follow instructions per the site policy and procedures.

- Periodic cleaning and disinfection are required.
- Do not use spray on cleaners or disinfectants. These can leak through openings and coat electrical components.
- Consult with the manufacturer or their agent if you have any doubts about the compatibility of decontamination or cleaning agents with the parts of the equipment or with the material contained in it.
- Do not use cleaners or disinfectants that contain solvents capable of harming paint coatings or stainless steel surfaces. **Do not use chlorine-based bleaches or abrasives; these will damage the tank.**

Warning: Exercise caution if cleaning the unit with alcohol or flammable cleaners. Always allow the unit to cool down to room temperature prior to cleaning and make sure all cleaning agents have evaporated or otherwise been completely removed prior to putting the unit back into service.

Avertissement: Soyez prudent lorsque vous nettoyez l'appareil avec de l'alcool ou des produits de nettoyage inflammables. Laissez toujours refroidir l'appareil à la température ambiante avant le nettoyage et assurez-vous que tous les produits de nettoyage se sont évaporés ou ont été complètement enlevés avant de remettre l'appareil en service.



Cleaning the Bath

1. Disconnect the unit from its power supply.
2. Remove beads and any other accessories from the tank.
3. Clean the unit with a mild soap and water solution, including all corners.
 - **Do not use an abrasive cleaner**, these will damage metal surfaces.
 - **Do not use deionized water to rinse or clean with.**
 - Take special care when cleaning around the temperature sensor probe in the tank to prevent damage. Do not clean the probe.
4. Clean with a lint-free towel dampened with distilled water and wipe dry with a soft cloth.

Disinfecting the Bath

For maximum effectiveness, disinfection procedures are typically performed after cleaning. Keep the following points in mind when disinfecting the unit.

- Turn off and disconnect the unit to safeguard against electrical hazards.
- Beads must be removed from the tank to successfully disinfect the bath.
- Disinfect the unit using commercially available disinfectants that are non-corrosive, non-abrasive, and suitable for use on stainless steel and glass surfaces. Contact your local Site Safety Officer for detailed information on which disinfectants are compatible with your applications.
- Disinfect all surfaces in the tank, making sure to thoroughly disinfect the corners. Exercise care to avoid damaging the sensor probes.
- Gas concentrations from evaporating disinfecting agents can inhibit growth or cause metabolic symptoms in microbiological sample populations. Make sure that chlorines, quaternary ammonias, or any other overtly volatile disinfecting agents have been rinsed or otherwise removed from the unit surfaces, prior to placing samples in the tank.

When disinfecting external surfaces, use disinfectants that will not damage painted metal, glass, and plastic.



CLEANING AND DISINFECTING LAB ARMOR BEADS

Clean and disinfect the beads as often as required by your laboratory protocol. **Always wear gloves when handling beads to avoid contaminating the beads and bath.**

Cleaning the Beads

1. Remove the beads from the tank.
2. Clean with a mild soap and water solution.
 - **Do not use abrasive cleaners.** These will damage the surface of the beads.
 - **Do not autoclave the beads.** This will cause pitting on the polished aluminum surfaces.
 - **Do not use deionized water to rinse or clean with.**
3. Rinse with distilled water and disinfect before use.

Disinfecting the Beads

1. Remove beads from the tank.
2. Disinfect the beads with a solution of isopropanol (IPA), ensuring that all bead surfaces have been sufficiently coated.
3. The manufacturer recommends allowing the IPA solution to air dry. This helps ensure that the beads have had sufficient contact time to be thoroughly disinfected.
4. Ensure that disinfecting agents have fully evaporated and beads are completely dry before returning beads to the tank.

MINIMIZING CONTAMINATION EXPOSURE

The following are suggestions for minimizing exposure of the unit to potential contaminants.

- Maintain a high air quality in the laboratory workspaces around the unit.
- Avoid placing the unit near sources of air movement such as doors, air vents, or high traffic routes in the workspace.

ELECTRICAL COMPONENTS

Electrical components do not require maintenance. If the unit fails to operate as specified, please contact your distributor or [Technical Support](#) for assistance.

CALIBRATE THE TEMPERATURE DISPLAY

Note: Performing a temperature display calibration requires a temperature reference device. Please see the [Reference Sensor Devices entry](#) on page 8 for device requirements.

Temperature calibrations are performed to match the unit temperature display to the actual temperature of the beads. The actual temperature is supplied by a calibrated reference device. Calibrations compensate for long-term drifts in the microprocessor controller as well as those caused by the natural material evolution of the sensor probe in the tank. Calibrate as often as required by your laboratory or production protocol, or regulatory compliance schedule. Always calibrate to the standards and use the calibration setup required by your industry requirements or laboratory protocol.

Suggested Calibration Setup

Heat-resistant non-stick tape recommended

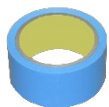

1. Introduce the reference device thermocouple probe into the tank. Rigid, non-conductive items, such as a wooden tongue depressor, may be used as a brace for the probe.

2. Position the sensor probe head as close as possible to the geometric center point of the chamber at least 2 inches (51 mm) from the bottom of the tank to prevent heatsinking. The probe head must be fully submerged in the beads.

3. Secure the probe head in position using non-stick tape.

4. Place the cover on the unit.

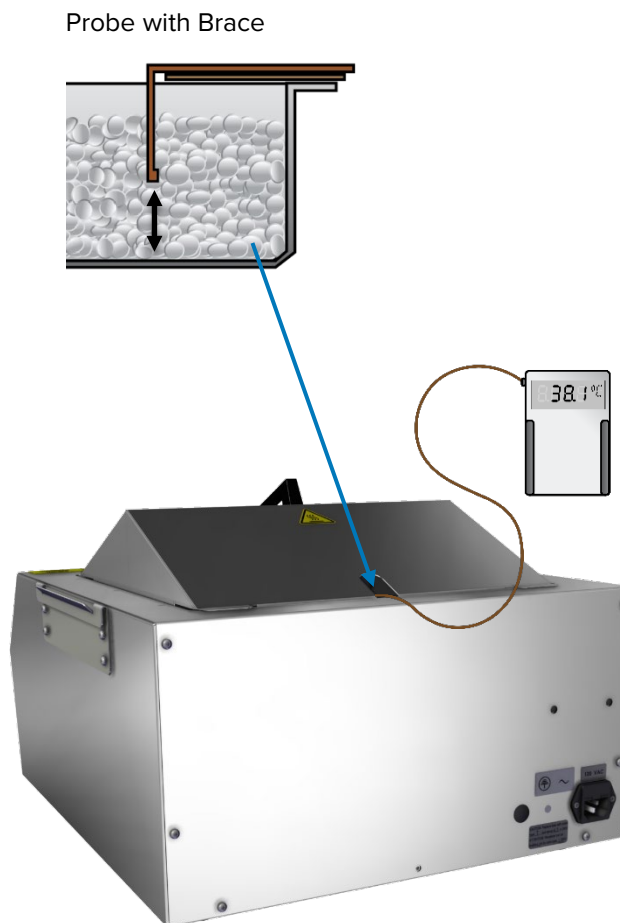

MAINTENANCE

5. The bead temperature must be stable in order to perform an accurate calibration.

- The temperature is considered stabilized when the filled bead bath has operated at your calibration temperature for at least 1 hour with no fluctuations greater than the specified temperature stability of the unit (see page 42).

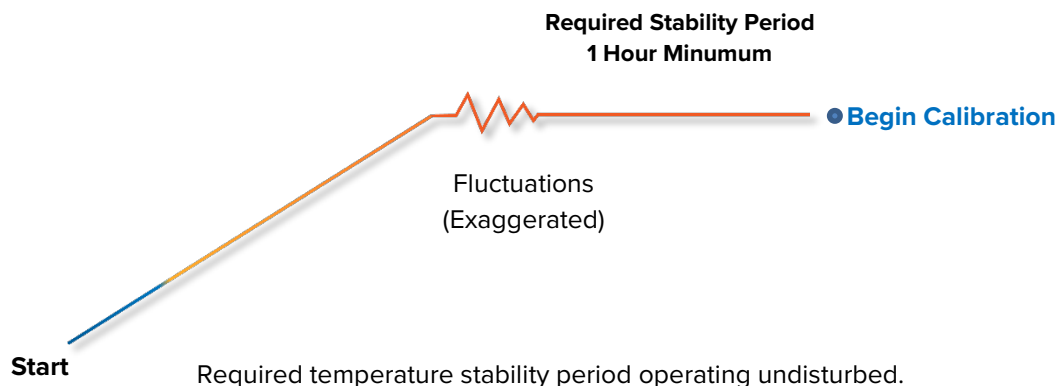

Suggested Temperature Calibration

1

Once the bead temperature has stabilized, compare the reference device and unit temperature display readings.

- If the readings are the same, or the difference between the two falls within the acceptable range of your protocol, the display is accurately showing the bead temperature. **The Temperature Calibration procedure is now complete.**



-OR-

- If the difference falls outside of your protocol range, advance to Step 2.

Set Temperature



2

A display calibration adjustment must be entered to match the display to the reference device. See next step.



Continued next page

MAINTENANCE

Temperature Calibration Continued

3

Place the display in temperature calibration mode.



- Press and hold both the **Up** and **Down** arrow buttons simultaneously for approximately 5 seconds.
- Release the buttons when the temperature display shows the letters "C O". The display will begin flashing the **current temperature display value**.



Note: The display will automatically exit calibration mode after 5 seconds of inactivity, with the last shown temperature display value saved.

4



Push the **Up** and **Down** arrow buttons to adjust the current display temperature value until it matches the reference device temperature reading.

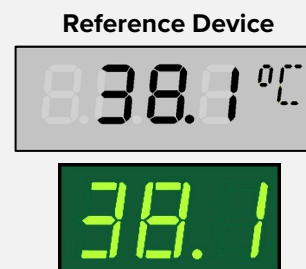

5

After matching the display to the reference device, wait 5 seconds.



Wait 5 Seconds

- The temperature display will cease flashing and store the corrected display value.
- The bead bath will now begin heating or passively cooling to reach the set point with the corrected display value.

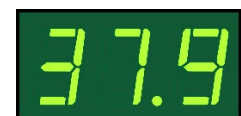

Cooling to Set Point

6



Wait 1 Hour

Allow the bead bath to operate for at least 1 hour undisturbed to stabilize **after the unit has achieved the corrected temperature set point**.

- Failure to wait until the unit is fully stabilized will result in an inaccurate reading.



Set Point Achieved

Continued on next page

Temperature Calibration Continued

7

Compare the reference device reading with the unit temperature display again.

- If the reference device and the unit temperature display readings are the same, or the difference falls within the range of your protocol, **the unit is now calibrated for temperature.**

-OR-

- See the next step if the readings fail to match or fall outside of your protocol range.

Reference Device



8

If the two readings are not the same, and the difference still falls outside the acceptable range of your protocol, repeat steps 3 – 7 up to two more times.

- Three calibration attempts may be required to successfully calibrate units that are more than $\pm 2^{\circ}\text{C}$ out of calibration.

Reference Device

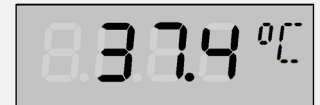

9

If the temperature readings of the unit temperature display and the reference device still fall outside your protocol after three calibration attempts, contact your distributor or [Technical Support](#) for assistance.

End of procedure



UNIT SPECIFICATIONS

These bead baths are 100 – 120 volt units. Please refer to the unit data plate for individual electrical specifications.

Technical data specified applies to units with standard equipment at an ambient temperature of 25°C and at nominal voltage. The temperatures specified are determined in accordance with factory standard following DIN 12880 respecting the recommended wall clearances of 10% of the height, width, and depth of the inner chamber. All indications are average values, typical for units produced in the series. We reserve the right to alter technical specifications at all times.

WEIGHT

Model	Shipping	Net Weight
74300-706	23 lb / 11 kg	13.0 lb / 5.9 kg
74300-714	37 lb / 17 kg	18.0 lb / 8.2 kg
74300-720	38 lb / 18 kg	22.0 lb / 10.0 kg

DIMENSIONS

In inches

Model	Exterior W × D × H	Interior W × D × H
74300-706	15.9 x 12.3 x 8.5 in	12.0 x 6.1 x 6.0 in
74300-714	15.9 x 18.5 x 8.5 in	12.0 x 12.1 x 6.0 in
74300-720	15.9 x 23.4 x 8.5 in	12.0 x 17.1 x 6.0 in

In millimeters

Model	Exterior W × D × H	Interior W × D × H
74300-706	404 x 312 x 216 mm	305 x 155 x 152 mm
74300-714	404 x 470 x 216 mm	305 x 307 x 152 mm
74300-720	404 x 594 x 216 mm	305 x 434 x 152 mm

SPECIFICATIONS

CAPACITY

Model	Cubic Feet*	Liters*
74300-706	0.21	6.0
74300-714	0.5	14.0
74300-720	0.71	20.0

*See page 7 for recommended volume of beads.





TEMPERATURE

Model	Range	Uniformity	Stability
All	Ambient +5°C to 80°C	±1.0°C @ 37°C	±0.1°C @ 37°C



POWER

Model	Voltage	Amperage	Frequency
74300-706	100 – 120	3.0	50/60 Hz
74300-714	100 – 120	4.5	50/60 Hz
74300-720	100 – 120	6.0	50/60 Hz

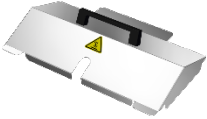
PARTS LIST

Description	Parts Number	Description	Parts Number
Fuse, 6.3 amp 250V	 3300515	74300-714 Gable Cover	 9751201
Power Cord, 110V, 15A, 9 ft 5 in (2.86 m) NEMA 5-15P	 1800510	74300-720 Gable Cover	 9751202
74300-706 Gable Cover	 9751203		

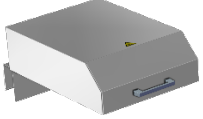
Accessories

Description	Parts Number	Description	Parts Number
6L Tall Vessel Lid	 9521387	20L Tall Vessel Lid	 9521389
14L Tall Vessel Lid	 9521388	Lab Armor Beads	
		0.75 liters	42370-750
		2 liters	42370-002
		4 liters	42370-004
		8 liters	42370-008

Ordering

Accessories and replacement parts can be ordered online from parts.sheldonmfg.com.

If the required item is not listed online, or if you need assistance in determining which part or accessory you need for your unit, parts may be ordered from SHEL LAB by emailing parts@sheldonmfg.com, or by phone at 1-800-322-4897 ext. 4, or (503) 640-3000 ext. 4.

Please have the **model**, **serial**, and **part** numbers of the unit ready, as Tech Support will need this information to match your unit to its correct part.



APPENDIX

Warning: Exercise caution when closing the lid to avoid injury to hands and fingers.

Avertissement: Soyez prudent lorsque vous fermez le couvercle pour éviter de vous blesser aux mains et aux doigts.



TALL VESSEL LID

Lab Armor offers a tall vessel lid to be used in place of the standard cover. See page 43 for ordering information.

1. Attach the handle to the lid, using the procedure on page 20.
2. Slide the hinged bracket over the rear wall of the tank to secure the lid to the unit.

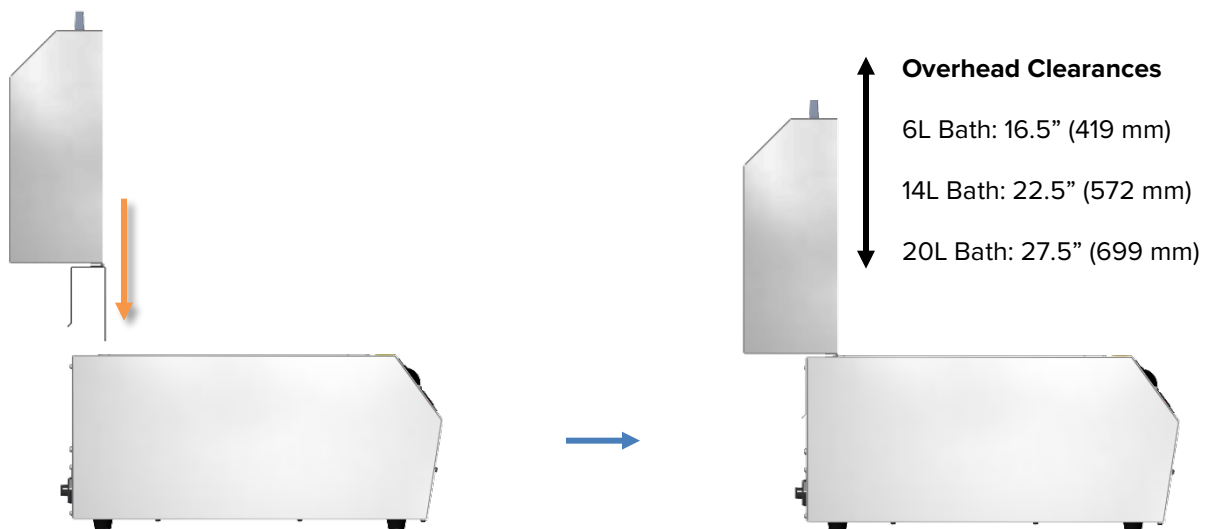

Lab  ARMOR[®]



SHELDON
MANUFACTURING, INC 

Lab Armor
2010 Century Center Blvd, Suite 21
Irving, TX 75062
USA

support@sheldonmfg.com
labarmor.com

1-800-322-4897
+1-503 640-3000
FAX: +1-503 640-1366