

# Installation – Operation Manual

**Hypoxia Chamber**

**BACTROX-2**

**220 – 240 Volts**



**Warning:** This product contains chemicals, including Triglycidyl Isocyanurate, known to the State of California to cause cancer as well as birth defects or other reproductive harm. For more information, go to [www.P65Warnings.ca.gov](http://www.P65Warnings.ca.gov).



**¡Advertencia!** Este producto contiene sustancias químicas, incluido el triglicidil isocianurato, que el estado de California sabe que causa cáncer, así como defectos de nacimiento u otros daños reproductivos. Para obtener más información, visite [www.P65Warnings.ca.gov](http://www.P65Warnings.ca.gov).

**Avertissement!** Ce produit peut vous exposer à des produits chimiques, dont l'isocyanurate de triglycidyle, reconnu par l'État de Californie pour provoquer le cancer, des anomalies congénitales ou d'autres problèmes de reproduction. Pour plus d'informations, visitez le site [www.P65Warnings.ca.gov](http://www.P65Warnings.ca.gov)

# BACTROX HYPOXIA CHAMBER 220 – 240 Volts

## Installation and Operation Manual

Part Number (Manual): 4861715

Revision: February 2, 2024



BACTRON is a brand of Sheldon Manufacturing, INC, an ISO 9001 certified manufacturer.



### Safety Certifications

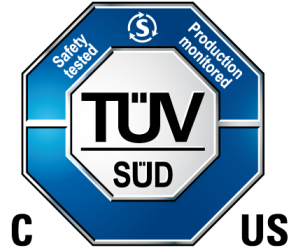

These units are CUE listed by TÜV SÜD as climatic chambers for professional, industrial, or educational use where the preparation or testing of materials is done at an ambient air pressure range of 22.14 – 31.3 inHg (75 – 106 kPa) and no flammable, volatile, or combustible materials are being heated.

These units have been tested to the following requirements:

- IEC 61010-1:2010
- IEC 61010-1:2010/AMD1:2016
- IEC 61010-2-010:2019
- CSA C22.2 No. 61010-1:2012/A1:2018-11
- UL 61010-1:2012/R:2019-07
- EN 61010-1:2010/A1:2019
- CSA C22.2 No. 61010-2-010:2019
- UL 61010-2-010:2019



# TABLE OF CONTENTS

<b>INTRODUCTION .....</b>	<b>7</b>
<i>Read this Manual.....</i>	7
<i>Safety Considerations and Requirements .....</i>	7
<i>Contacting Assistance.....</i>	8
<i>Engineering Improvements.....</i>	8
<i>Manufacturing Defect Warranty.....</i>	8
<i>Gas Sources and Usage .....</i>	9
<i>Gas Sensor Calibrations .....</i>	10
<i>Temperature Calibrations.....</i>	11
<i>Condensate Receptacle.....</i>	11
<b>RECEIVING YOUR UNIT .....</b>	<b>12</b>
<i>Inspect the Shipment .....</i>	12
<i>Orientation.....</i>	13
<i>Record Data Plate Information .....</i>	15
<b>INSTALLATION .....</b>	<b>16</b>
<i>Installation Check List.....</i>	16
<i>Required Ambient Conditions .....</i>	17
<i>Sufficient Workspace .....</i>	17
<i>Environmental Disruption Sources .....</i>	17
<i>UV Damage.....</i>	18
<i>Ventilation and Low Oxygen Conditions .....</i>	18
<i>Power Requirements.....</i>	18
<i>Lifting and Handling .....</i>	19
<i>Removing from the Pallet.....</i>	19
<i>Leveling.....</i>	19
<i>Install the Chamber.....</i>	20
<i>Connect to Gas Sources.....</i>	20
<i>Deionized and Distilled Water.....</i>	21
<i>Installation Cleaning and Disinfection .....</i>	21
<i>Place Accessories .....</i>	21
<i>Install the Incubator Shelf Spacers.....</i>	22
<i>Open the Incubator Doors .....</i>	22
<i>Install the Arm Port Doors.....</i>	23
<i>Attach the Sleeves .....</i>	24
<i>Pass Box Vent Cover.....</i>	25
<b>GRAPHIC SYMBOLS.....</b>	<b>26</b>
<b>CONTROL PANEL OVERVIEW .....</b>	<b>28</b>
<b>OPERATION .....</b>	<b>32</b>
<i>Theory of Operation .....</i>	32
<i>Put the BACTROX into Operation.....</i>	36
<i>Turn on the BACTROX.....</i>	37
<i>Establish a Hypoxic Atmosphere.....</i>	37
<i>Set the Incubator Temperature .....</i>	40
<i>Chamber Entry.....</i>	41
<i>Chamber Movement Techniques.....</i>	42
<i>Exit the Chamber.....</i>	42
<i>Operating the Pass Box.....</i>	44
<i>Set the Over Temperature Limit .....</i>	45
<i>Loading Samples.....</i>	46
<i>Humidifying the Incubator .....</i>	46

<i>Gas Conservation Methods</i> .....	47
<i>Chamber Power Outlet</i> .....	47
<i>Data Outputs and Logging</i> .....	47
<i>Adjust the Gas Set Points</i> .....	49
<i>Mute the Audible O<sub>2</sub> / CO<sub>2</sub> Alarms</i> .....	51
<i>Activated Carbon Scrubber and Rejuvenation Cycle</i> .....	52
<b>USER MAINTENANCE</b> .....	<b>53</b>
<i>Daily Maintenance</i> .....	55
<i>Door Gasket Maintenance and Usage</i> .....	55
<i>Sleeves Maintenance and Usage</i> .....	55
<i>Replacing the Sleeve Cuffs</i> .....	56
<i>Cleaning and Disinfecting</i> .....	57
<i>Maintaining the Acrylic Glass Panels</i> .....	60
<i>Electrical Components</i> .....	60
<i>Condensation and the Dew Point</i> .....	61
<i>Calibrate the O<sub>2</sub> Sensor and Display</i> .....	62
<i>Calibrate the CO<sub>2</sub> Display</i> .....	80
<i>Calibrate the Temperature Display</i> .....	84
<b>UNIT SPECIFICATIONS</b> .....	<b>89</b>
<i>Weight</i> .....	89
<i>Unit Dimensions</i> .....	89
<i>Stand Dimensions</i> .....	89
<i>Pass Box Capacity</i> .....	90
<i>Workspace Capacity</i> .....	90
<i>Incubator Temperature</i> .....	91
<i>Incubator Capacity</i> .....	91
<i>Gas Ranges</i> .....	91
<i>Power</i> .....	91
<b>PARTS LIST</b> .....	<b>93</b>
<b>ACCESSORIES</b> .....	<b>99</b>
<b>APPENDIX</b> .....	<b>101</b>
<i>Calculating the O<sub>2</sub> Concentration</i> .....	101

# INTRODUCTION

*Thank you for purchasing a BACTROX Hypoxia Chamber. We know you have many choices in today's competitive marketplace when it comes to cultivation chambers. We appreciate you choosing ours. We stand behind our products and will be here for you if you need us.*

## ***READ THIS MANUAL***

Failure to follow the guidelines and instructions in this user manual may create a protection impairment by disabling or interfering with the unit safety features. This can result in injury or death.

Before using the unit, read the manual in its entirety to understand how to install, operate, and maintain the unit in a safe manner. Ensure all operators are given appropriate training before the unit begins service.

Keep this manual available for use by all operators.

## ***SAFETY CONSIDERATIONS AND REQUIREMENTS***

Follow basic safety precautions, including all national laws, regulations, and local ordinances in your area regarding the use of this unit. If you have any questions about local requirements, please contact the appropriate agencies.

### **SOPs**

Because of the range of potential applications this unit can be used for, the operator or their supervisors must draw up a site-specific standard operating procedure (SOP) covering each application and associated safety guidelines. This SOP must be written and available to all operators in a language they understand.

### **Intended Applications and Locations**

BACTROX climatic chambers are intended for professional, industrial, and educational applications suitable for the cultivation of clinical bacteria. These units are not intended for use at hazardous or household locations. Only use this equipment for its intended range of applications.

### **Power**

Your unit and its recommended accessories are designed and tested to meet strict safety requirements.

- The unit is designed to connect to a power source using the specific power cord type shipped with the unit.
- Always plug the unit power cord into a protective earth grounded electrical outlet conforming to national and local electrical codes. If the unit is not grounded properly, parts such as knobs and controls can conduct electricity and cause serious injury.
- Do not bend the power cord excessively, step on it, or place heavy objects on it.
- A damaged cord can be a shock or fire hazard. Never use a power cord if it is damaged or altered in any way.
- Use only approved accessories. Do not modify system components. Any alterations or modifications to your unit not explicitly authorized by the manufacturer can be dangerous and will void your warranty.

## *CONTACTING ASSISTANCE*

Phone hours for Support are 6 am – 4:30 pm Pacific Coast Time (west coast of the United States, UTC - 8), Monday – Friday.

Please have the following information ready when calling or emailing Technical Support: the **model number**, **serial number**, and the **part number**. These will be found on the unit data plate located in the workspace chamber above the inner pass box door. See page 15.

[support@sheldonmfg.com](mailto:support@sheldonmfg.com)

1-800-322-4897 extension 4  
(503) 640-3000 extension 4

FAX: (503) 640-1366

Sheldon Manufacturing, INC.  
P.O. Box 627  
Cornelius, OR 97113  
USA

## *ENGINEERING IMPROVEMENTS*

Sheldon Manufacturing continually improves all of its products. As a result, engineering changes and improvements are made from time to time. Therefore, some changes, modifications, and improvements may not be covered in this manual. If your unit's operating characteristics or appearance differs from those described in this manual, please contact your equipment dealer or distributor for assistance.

## *MANUFACTURING DEFECT WARRANTY*

For information on your warranty and online warranty registration please visit:

[sheldonmanufacturing.com/warranty](http://sheldonmanufacturing.com/warranty)



---

**Note:** Never introduce hydrogen in any quantity into the BACTROX. Hydrogen will destroy the oxygen-sensing zirconium dioxide sensor and the ability of the BACTROX to regulate oxygen levels. Use of hydrogen in a BACTROX voids the manufacturing warranty.

---



## *GAS SOURCES AND USAGE*

A constant supply of gas nitrogen ( $N_2$ ) is required for operation of the BACTROX. Gas nitrogen is also abbreviated as  $GN_2$  by some gas suppliers.

Before installing a BACTROX, contact your site safety officer and review your institutional safety protocols for handling, storing, securing, and using compressed gases. Follow all local ordinances and national regulations regarding compressed gases in your research or production environment



---

**Note:** Always use medical or food-grade gas supplies. Use of industrial-grade gases risks introducing contaminants into the chamber, may damage chamber components, and will void the manufacturing defect warranty.

---

### **Gas Source Considerations**

- Nitrogen is required for purging oxygenated standard atmosphere from the workspace and maintaining a hypoxic environment.
- Carbon dioxide gas ( $CO_2$ ) may be used to enrich the hypoxic chamber environment.  $N_2$  is still required for creating and keeping hypoxic conditions in the chamber.
- Always use a two-stage gas pressure regulator to ensure consistent metering for all gases. Some single-stage regulators have two (2) gauges. Make certain your regulator is a two-stage regulator.
- The BACTROX uses injections of air drawn from the laboratory environment to raise the concentration of oxygen inside the workspace chamber to match the current user-programmed set point.

### **Usage Rates**

- The BACTROX requires approximately 400 lb of  $N_2$  tank pressure (from a size 300 cylinder) to purge the workspace chamber down to a 1%  $O_2$  concentration.
- $N_2$  usage rates during normal operations vary considerably. Among the major factors driving usage are the  $O_2$  set point (the lower the set point, the higher the rate of use) and if  $CO_2$  is being added to the chamber atmosphere.
- Accessing and working in the workspace chamber significantly increases the consumption rate of  $N_2$ . Proper entry and exit techniques, along with proper movement technique while in the chamber, are essential for reducing  $N_2$  usage. Proper techniques are covered in the Operation section of this manual (page 41).

## *GAS SENSOR CALIBRATIONS*

### **O<sub>2</sub> Calibrations**

The BACTROX oxygen sensor requires periodic calibrations to compensate for drifts in accuracy. These drifts are caused by a naturally occurring material evolution of the sensor during its operational life. The sensor can be calibrated to a single O<sub>2</sub> value with a matching reference gas supply. However, a dual point calibration at a high value and then a low value provides accuracy across a range of O<sub>2</sub> concentrations. The high-value sample may be drawn from the ambient atmosphere, after calculating oxygen concentration of the room air (please see page 101). Since the low value must be below the atmospheric concentration, a reference sample supply with a known hypoxic O<sub>2</sub> concentration is required. Single point calibrations at hypoxic values also require a manufactured reference gas.

Only use oxygen – nitrogen mixes for O<sub>2</sub> sensor calibrations. Do not use O<sub>2</sub> – CO<sub>2</sub> mixes, even if you will be running a carbon dioxide-enriched environment during your study.

Calibration mixes are sometimes referred to as **Certified Standard Mixtures** or **Portable Calibration Gases** with a **% Oxygen** by gas suppliers and are purchased in supply cylinders requiring a regulator and tubing to connect to the BACTROX. Check with your gas supplier for the appropriate regulator type.

O<sub>2</sub> sensor calibrations typically only use a small volume of gas.

**Factory Calibration:** The BACTROX is dual-point calibrated at the factory. The low value is supplied with a certified standard gas mix purchased from Airgas with 5% O<sub>2</sub> – 95% N<sub>2</sub> balance (Airgas part number X02NI95C3006050). Airgas also provides other certified O<sub>2</sub> – N<sub>2</sub> mixes suitable for accurately calibrating the BACTROX at a variety of hypoxic values.

These include:

1% O <sub>2</sub> – 99% N <sub>2</sub>	8% O <sub>2</sub> – 92% N <sub>2</sub>
3% O <sub>2</sub> – 97% N <sub>2</sub>	10% O <sub>2</sub> – 90% N <sub>2</sub>
5% O <sub>2</sub> – 95% N <sub>2</sub>	21% O <sub>2</sub> – 79% N <sub>2</sub>

### **CO<sub>2</sub> Calibrations**

The carbon dioxide (CO<sub>2</sub>) sensor does not require a calibration gas. A digital reference gas analyzer capable of detecting CO<sub>2</sub> concentrations at least of 0.1% will suffice and must be purchased separately.

## *TEMPERATURE CALIBRATIONS*

### **A reference sensor must be purchased separately**

A reference sensor device is required for calibrating the BACTROX incubator temperature display.

Reference devices must meet the following standards:

- Accurate to at least 0.1°C

The device should be regularly calibrated, preferably by a third party.

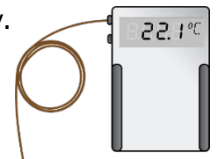

**Temperature Reference**

### **Temperature Probe**

Use a digital device with a wire thermocouple probe that can be introduced into the incubator through the incubator door space. Select thermocouples suitable for the application temperature you will be calibrating at.

### **Why Probes?**

Reference readings taken outside an incubator using a wire temperature probe do not require opening the incubator doors. Door openings disrupt the incubator temperature and requires a **minimum 1-hour wait** to allow the temperature to re-stabilize before continuing.

### **No Alcohol or Mercury Thermometers**

Alcohol thermometers do not have sufficient accuracy to conduct accurate temperature calibrations. **Never place a mercury thermometer in an incubator.** Always use thermocouple probes.

## *CONDENSATE RECEPTACLE*

The BACTROX comes with an integral Peltier effect chiller for capturing excess humidity on an internal cold plate. The condensate is then collected in a small reservoir that drains through a plastic tube into the workspace chamber.



- An open container, such as a beaker or flask, must be placed beneath the drain tube and drained regularly.

# RECEIVING YOUR UNIT

## *INSPECT THE SHIPMENT*

When a unit leaves the factory, safe delivery becomes the responsibility of the carrier. **Damage sustained during transit is not covered by the manufacturing defect warranty.**

When you receive your unit, inspect it for concealed loss or damage to its interior and exterior. If you find any damage to the unit, **follow the carrier's procedure for claiming damage or loss.** Save the shipping carton until you are certain that the unit and its accessories function properly.

1. Carefully inspect the shipping carton for damage.
2. Report any damage to the carrier service that delivered the unit.
3. If the carton is not damaged, open the carton and remove the contents.
4. Inspect the unit for signs of damage. Use the orientation images in this chapter as references.
5. The unit should come with an Installation and Operation Manual.
6. Verify the correct number of accessory items has been included.
7. Carefully check all packaging for accessory items before discarding.

**Arm Port Door  
Left**



**Arm Port Door  
Right**



**Gas Regulator,  
CO<sub>2</sub>**



**Gas Regulator,  
Nitrogen**



**3 Incubator  
Shelf Spacers**



**4 Leveling Feet\***



**Power Cord  
CEE7/7 Euro**



**2 Rubber Cuff  
Plugs**



**7 Petri Dish Racks**



**2 Sleeve  
Assemblies**



(Size 9 Large)

**Calibration  
Ambient Air  
Sample Pump**



**Calibration Kit**



**Cover**

**Cal / Data  
Logging RS232  
Cable**



**Calibration  
RS232 to USB  
Adaptor Kit**



**Document  
Shelf**



\*BACTROXes shipped mounted on a stand do not include leveling feet.

# RECEIVING

## ORIENTATION

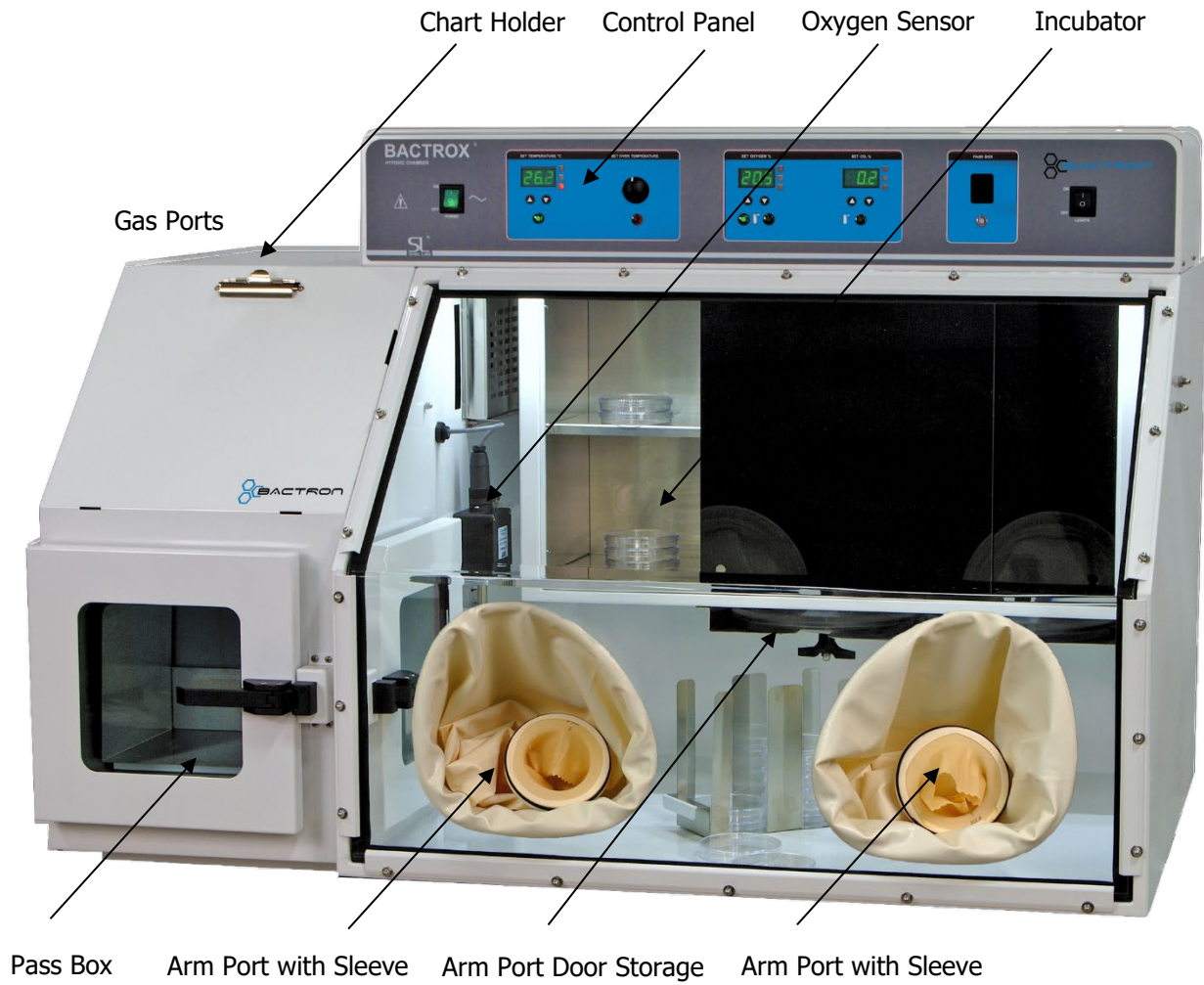

**BACTROX-2 Exterior**

Additional Chamber Orientation



O<sub>2</sub> Sensor

Oxygen Sensor

Power Outlet. The outlet type varies by voltage.

Sensor Cage

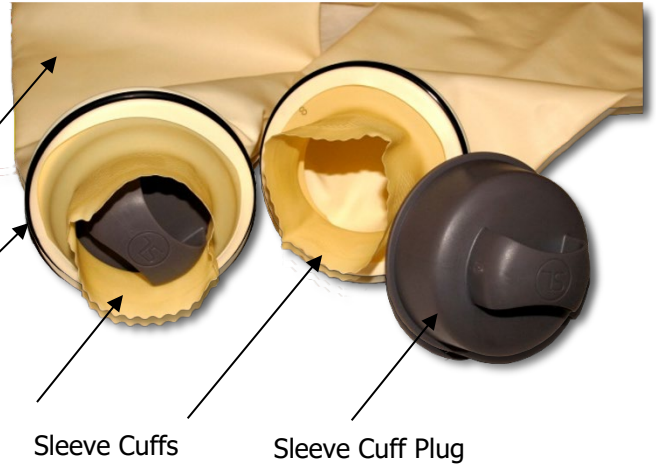
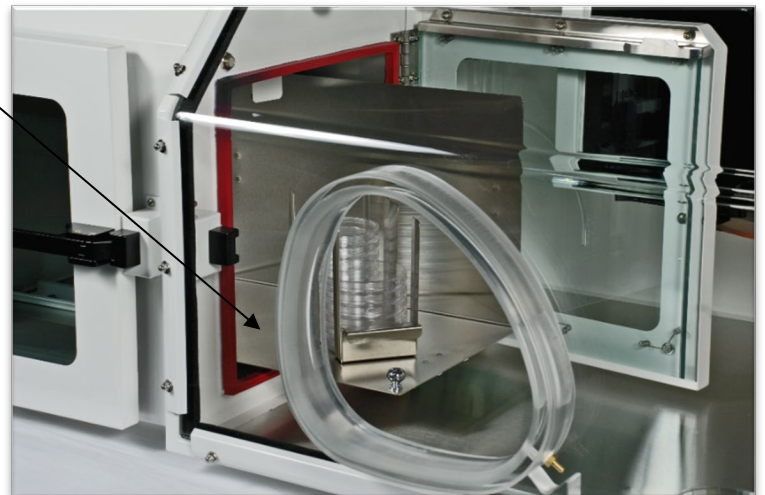

Figure 1: Sleeve Assemblies

Pass Box Sliding Shelf

Pass Box



## Vents – Back of the Unit



### Chamber Vent

Oxygenated atmosphere is forced out of the workspace chamber through this vent. Do not plug or obstruct.

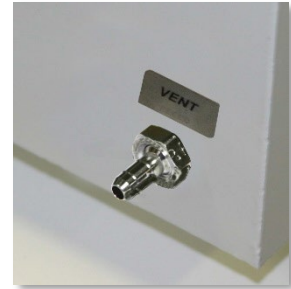

### Pass Box Vent

During pass box cycles evacuated air is exhausted through this vent. The pass box vent should never be plugged while the unit is in operation. Remove the vent cover after installing the unit.

## *RECORD DATA PLATE INFORMATION*

The data plate contains the chamber **model number, serial number, and part number**. Tech Support will need this information during any support call. Record it below for future reference.

- The data plate is located in the workspace chamber above the inner pass box door.

## Data Plate Information

<b>MODEL NO:</b>	
<b>SERIAL NO:</b>	
<b>PART NO:</b>	



## *INSTALLATION CHECK LIST*

Perform the procedures in this chapter when the unit is installed in a new location.

### **Pre-Installation**

- ✓ Check that the required ambient and spacing conditions are met, page 17
- ✓ Check for sources of temperature and atmospheric disruption in the environment, page 17
- ✓ Verify no damaging UV light sources and sufficient ventilation are present, page 18
- ✓ Check that a suitable electrical outlet is present, page 18
- ✓ Procure gas supplies for suitable for your hypoxia application. See page 9 for gas requirements.

### **Install the BACTROX in a suitable location**

- ✓ Review lifting and handling instructions, page 19
- ✓ Install the chamber, page 20

### **Set up the BACTROX for use**

- ✓ Connect the gas supplies to the BACTROX, page 20
- ✓ Clean and disinfect the BACTROX, accessories, and items that will be placed in the chamber, page 21
- ✓ Install shelf spacers in the workspace incubator. Leave the incubator doors open, page 22
- ✓ Install the arm port doors and sleeves, pages 23 and 24
- ✓ Remove the pass box vent cover, page 25



## *REQUIRED AMBIENT CONDITIONS*

These units are intended for use indoors, at room temperatures between **15°C and 30°C (59°F and 86°F)**, at no greater than **80% Relative Humidity** (at 25°C / 77°F). Operating the unit outside of these conditions may adversely affect its incubator temperature stability and effective operating range.

## *SUFFICIENT WORKSPACE*

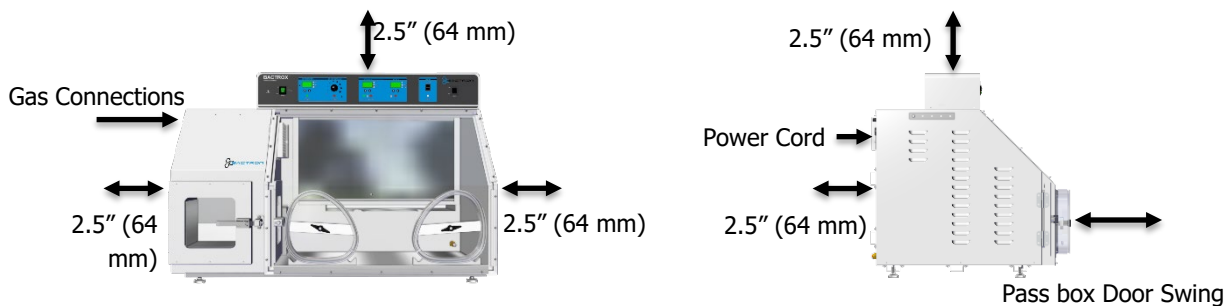

**2.5 inches (64 mm) minimum** clearances are required for unobstructed airflow and cooling.

- **Gas Connections:** The BACTROX requires continual connection to 1 or 2 compressed gas sources. Make sure there is sufficient space for these connections.
- Please see page 89 for unit dimensions. Caster-mounted stands for BACTROXes are available for purchase, see page 100.

## *ENVIRONMENTAL DISRUPTION SOURCES*

When selecting a location to install the BACTROX in, check for potential sources of temperature and air flow disruptions. These can affect the chamber incubator temperature and atmospheric stability.

- Ovens, autoclaves, and any other device that produces significant radiant heat
- High-traffic areas
- Direct sunlight
- Heating and cooling ducts, or other sources of fast-moving air currents

Direct exposure to air-conditioning vents or other sources of cold air can result in **condensation or fogging** on the acrylic glass panels of the chamber, depending on humidity and other ambient conditions. Prolonged exposure to cold air flows may adversely affect the incubator temperature performance.

# INSTALLATION

## *UV DAMAGE*

Sustained exposure to direct sunlight, UVC, or UV germicidal lighting around 254nm will **rapidly age the BACTROX acrylic glass panels and arm port sleeves**. Check if your laboratory or workspace contains sources of UV lighting.

Periodic use of long-wave (365nm) UV hand lamps for bacterial identification should not damage the acrylic glass. See the [Maintaining the Acrylic Glass Panels](#) entry on page 60 for more details.

## *VENTILATION AND LOW OXYGEN CONDITIONS*

Leakage from several hypoxia chambers or CO<sub>2</sub> incubators operating in an improperly ventilated space can lead to lowered oxygen levels as CO<sub>2</sub>, N<sub>2</sub>, and other laboratory gases crowd out oxygen. The highest level of O<sub>2</sub> concentration achievable by the BACTROX is equal to the ambient (room) concentration. A low oxygen workspace environment around the BACTROX may have the following adverse effects:

- It can prevent the BACTROX from achieving your selected O<sub>2</sub> set point.
- It can interfere with an O<sub>2</sub> sensor calibration when using an ambient air sample.

## *POWER REQUIREMENTS*

**Power Source:** The power source for the unit must match the voltage and match or exceed the amperage requirements listed on the unit data plate. These units are intended for **220 – 240V 50/60 Hz** applications with a draw of **2.0 Amps**.

- **The unit may be damaged if the supplied voltage varies by more than 10% from the data plate rating.**
- The wall power source must be protective earth grounded.
- Use a separate circuit to prevent loss of the unit due to overloading or circuit failure.
- **The recommended wall circuit breakers for these units are 16 amps.**
- The wall power source must conform to all national and local electrical codes.

**Power Cord:** The unit must be positioned so that all end-users can quickly unplug the unit in the event of an emergency.

- The unit comes with a 220 – 240VAC, 8ft (2.5m), CEE7/7 power cord. Always use this cord or an identical replacement.

**Fuse:** These units come provided with 2 **Type T 4 5x20mm fuses**, with one installed in the power cord plug inlet on the back of the unit, and the other in an adjacent fuse holder.

- The unit must be fused in order to operate.

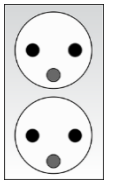

Standard  
CEE7/7 wall  
socket



## LIFTING AND HANDLING

The unit is heavy. Use appropriate lifting devices that are sufficiently rated for these loads. Follow these guidelines when lifting the unit.

- Lift the unit only from its bottom surface.
- Doors, handles, and knobs are not adequate for lifting or stabilization.
- Restrain the unit completely while lifting or transporting so it cannot tip.
- Remove all moving parts, such as shelves and trays, and lock doors in the closed position during transfers to prevent shifting and damage.

## REMOVING FROM THE PALLET

The unit comes secured to a shipping pallet with ½-inch hex bolts inserted through the 4 leveling feet holes on the bottom of the chamber. Use a socket wrench to remove the bolts and release the unit from the pallet.

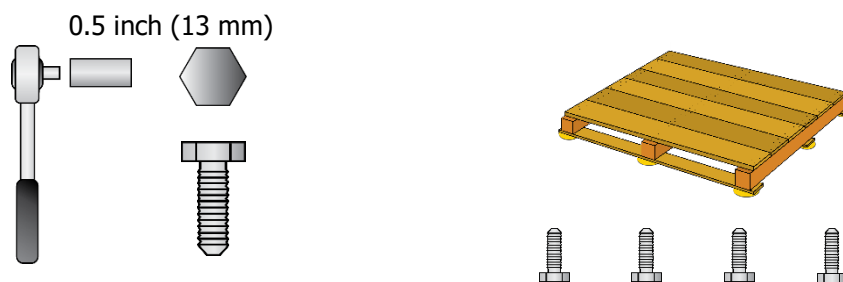

## LEVELING

Install the 4 leveling feet in the 4 corner holes on the bottom of the unit. The unit must be level and stable for safe operation.



---

**Note:** To prevent damage when moving the unit, turn all 4 leveling feet so that the leg of each foot sits inside the unit.

---

# INSTALLATION

## INSTALL THE CHAMBER

Install the unit in a workspace location that meets the criteria specified in the previous entries in the Installation section.

- Do not connect the unit to its power source at this time.

## CONNECT TO GAS SOURCES

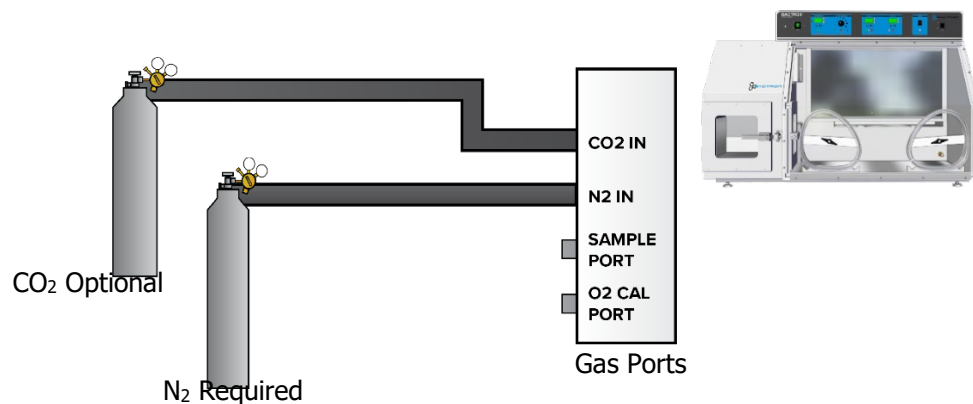

Match the correct gas regulator type to the correct gas type. A CO<sub>2</sub> regulator should always be used for CO<sub>2</sub> supplies, etc.

1. Install the dual-stage gas regulators on any gas-supply cylinders you will be using.
2. Set the supply regulators to deliver **15 – 20 psi** of pressure at the BACTROX gas in ports.
  - Do not exceed 20 psi of delivery at the ports.
3. Connect the nitrogen gas regulator or wall source to the N<sub>2</sub> IN port.
  - The BACTROX comes with ¼ inch OD connection tubing for connecting to gas supplies.
4. If using CO<sub>2</sub> in addition to nitrogen, connect the CO<sub>2</sub> cylinder regulator or wall source outlet to the CO<sub>2</sub> IN port.
5. **Do not open the gas valves at this time.**
  - Gas will be supplied to the BACTROX when establishing a hypoxic atmosphere, in the Operation chapter.

PSI	Megapascals	Kilopascals	Bar
15 - 20 PSI	0.103 – 0.138 Mpa	103.42 – 137.89 Kpa	1.03 – 1.38 bar

# INSTALLATION

## *DEIONIZED AND DISTILLED WATER*

**Do not use deionized water** to clean the unit, even if DI water is readily available in your laboratory.

- Use of deionized water may corrode metal surfaces and **voids the manufacturing warranty**.
- The manufacturer recommends the use of distilled water in the resistance range of 50K Ohm/cm to 1M Ohm/cm, or a conductivity range of 20.0 uS/cm to 1.0 uS/cm, for cleaning applications.

## *INSTALLATION CLEANING AND DISINFECTION*

The manufacturer recommends cleaning and disinfecting the chamber and its accessories prior to putting the unit into operation.

- The unit was cleaned at the factory but may have been exposed to contaminants during shipping.
- Remove all wrappings and coverings from shelving and other accessory items to cleaning and installation. **Do not clean the shelving with deionized water.**
- Please see the [Cleaning and Disinfection](#) procedure on page 57 in the User Maintenance chapter for information on how to clean and disinfect without damaging the unit.

## *PLACE ACCESSORIES*

The following items should be cleaned and disinfected as described above, then placed inside the BACTROX workspace chamber.

- Arm port doors. The doors should be stored in the hanging slots on the bottom of the workspace incubator during the setup.
- The calibration O<sub>2</sub> sensor cover plate.
- The incubator bottom shelf spacers. Introduce through the pass box.
- The petri dish racks. These can be placed on the top shelf of the workspace chamber incubator during the setup.
- A glass flask or beaker placed under the plastic condensation drain tube on the left side of the chamber.
- Any equipment or containers that will be used in the workspace chamber. Doing so now saves time and nitrogen by eliminating pass box purge cycles. If possible, containers should be placed in the chamber loose lidded or open to allow oxygen to be evacuated during hypoxic atmosphere setup. Sealed containers act as reservoirs of oxygen.



## *INSTALL THE INCUBATOR SHELF SPACERS*

These spacers ensure even heat distribution and uniformity.

1. Set the spacers on the **bottom shelf** of the workspace chamber incubator, side by side.
  - The "SPACER" label should face out toward you.

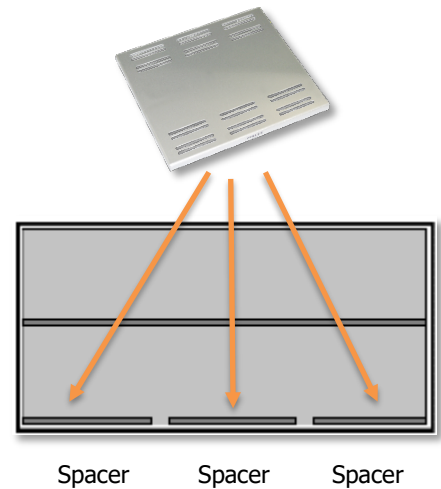

## *OPEN THE INCUBATOR DOORS*

The incubator doors must be open during the commissioning cycle when the BACTROX purges the aerobic atmosphere from the workspace chamber. Failure to do so will leave a significant reservoir of oxygenated standard atmosphere in the incubator.

Opening the doors now prepares the BACTROX for commissioning.

Workspace incubator doors left open

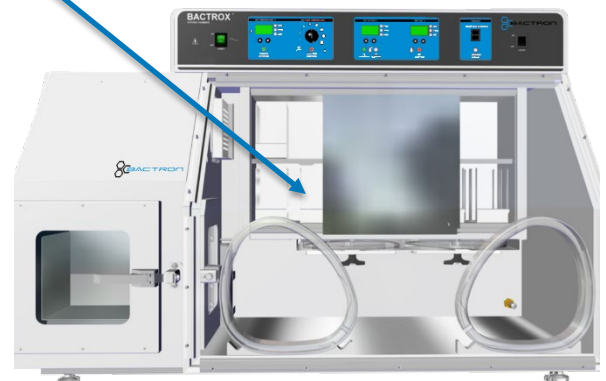

1

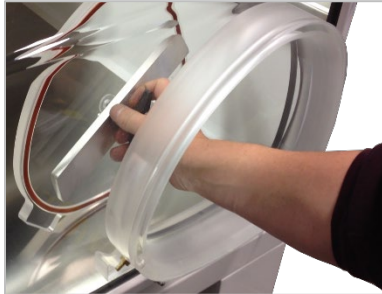

2



3



4



5



## *INSTALL THE ARM PORT DOORS*

The arm port doors must be installed to successfully purge the chamber atmosphere.

1. Turn the locking bar on both doors to a roughly 45° position.
2. Insert the tabs for one door into the slots on the bottom of its arm ports.
3. Pull the top of the door toward you so that it sits balanced and vertical in the arm port.
  - Repeat steps 2 and 3 for the second door.
4. Turn the locking bars on both doors to the horizontal position, one at a time.
5. Secure the doors one at a time by turning the black arm port doorknob clockwise.
  - The silver locking bar will move toward the body of the door.
  - Use wrist strength only. Turn until the knob grabs and feels snug. Tightening too much can damage the door.
6. Gently check that the doors sit snug in the ports.
  - The doors should not move when gently pulling on the locking bar or pushing against the door body. User finger strength only.
  - The locking bar should not move.

# INSTALLATION

## *ATTACH THE SLEEVES*

Attach and secure both sleeves to the arm ports. This allows reach-in access to the chamber through the ports without introducing aerobic external atmosphere.

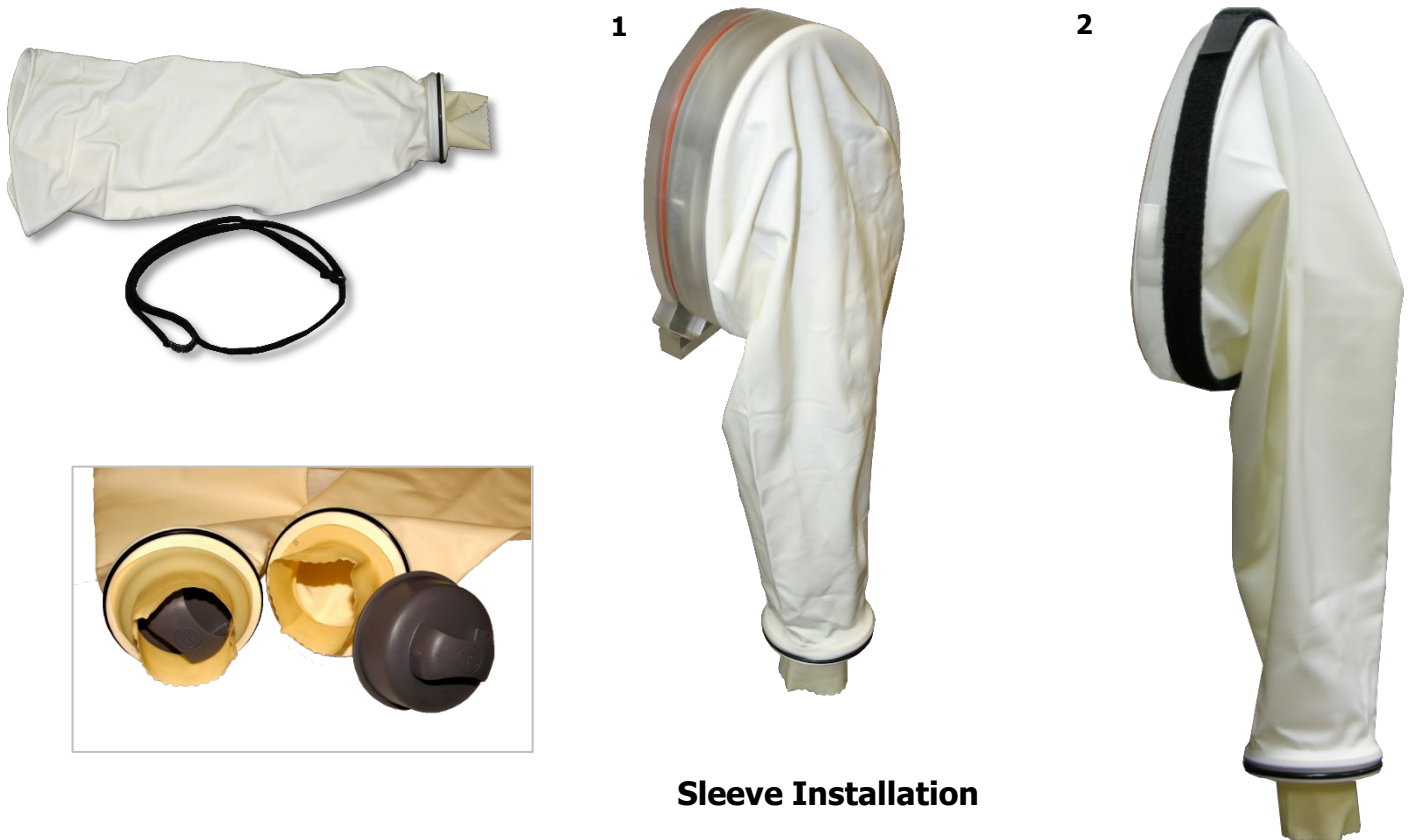

**Sleeve Installation**

### **Start with either arm port**

1. Unroll the large opening of a sleeve over the lip of the arm port door. Starting from the bottom of the arm port is typically the easiest approach.
  - a. Place the ring on the large end of the sleeve inside the groove on the arm port.
  - b. Make sure none of the sleeve material is trapped or pinched between the ring and the seating groove.
2. Secure the sleeve to the arm port using the 48 inch (1210 mm) self-gripping strap included with the sleeve.
3. Repeat the process for the second sleeve and arm port.
4. Insert both sleeve plugs.

**Note:** Sleeves may be left attached to the BACTROX when not in use.



# INSTALLATION

## *PASS BOX VENT COVER*

Remove the rubber cover from the pass box vent located on the back of the BACTROX on the lower right corner.







- Failure to remove the cover may prevent the BACTROX from achieving hypoxic conditions in the pass box during pass box cycles.



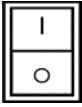

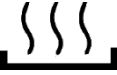

**Pass Box Vent**

# GRAPHIC SYMBOLS

The unit is provided with multiple graphic symbols located on its exterior and interior surfaces. The symbols identify hazards and the functions of the adjustable components as well as important notes found in the user manual.

Symbol	Definition
	Consult the user manual. Consulter le manuel d'utilisation
	I/ON O/OFF I indique que l'interrupteur est en position marche. O indique que le commutateur est en position d'arrêt.
	AC Power Repère le courant alternatif
	Gas injecting Injection de gaz
	Temperature display Indique l'affichage de la température
	Incubator heating Indique que l'incubateur chauffe
	Adjusts UP and DOWN Ajuster le haut et vers le bas
	Over Temperature Limit system Thermostat température limite contrôle haute

Symbol	Definition
	Indicates potential shock hazard Risque de choc électrique
	Recycle the unit. Do not dispose of in a landfill Recycler l'unité. Ne jetez pas dans une décharge
	Protective earth ground Terre électrique
	Manually adjustable Indique un réglage manuel

# CONTROL PANEL OVERVIEW



**Note: Control panel colors may vary**

## Power Switch

Controls all power to each chamber and its systems.



**Incubator & OTL Controls**

## Incubator Temperature Control and Display

During normal operations, the Set Temperature display shows the current incubator air temperature, accurate to 0.1°C. The Up and Down buttons are used to change display modes and then input either a new temperature set point or a calibration adjustment. The display blinks continually while in its set point or calibration adjustment modes, preceded by an "SP" for Set Point or "C O" for Calibration Offset.



The Heating indicator light illuminates when the BACTROX calls for power to the incubator heating elements.



## Set Over Temperature

This graduated dial sets the mechanical heating cut off for the Over Temperature Limit system (OTL). The OTL helps prevent unchecked heating of the chamber in the event of an electronics failure or external heat spike. For details, please see the [Over Temperature Limit System](#) description in the Theory of Operations (page 35).



The red Over Temperature Activated light illuminates when the OTL system cuts off heating to the unit chamber by rerouting power away from the heating elements.



## O<sub>2</sub> and CO<sub>2</sub> Controls



### Set OXYGEN %

5.0

This display shows the oxygen concentration in the workspace chamber as a percentage of the chamber atmosphere between 0 and 25%. The **UP / DOWN** arrow buttons are used to input an O<sub>2</sub> concentration set point for the workspace chamber atmosphere and to enter calibration offsets.



The O<sub>2</sub> sensor **requires 5 minutes** to warm up after the BACTROX is turned on before it will produce an accurate oxygen measurement.

LED lamps and an audible buzzer alarm signal gas concentration deviations of  $\pm 1\%$  from the O<sub>2</sub> set point. The yellow LED marked MUTE illuminates whenever an audible O<sub>2</sub> deviation alarm is being muted. There is a 15-minute delay for the activation of the low deviation buzzer alarm.

### N<sub>2</sub> Injecting / Air Injecting



The green N<sub>2</sub> light illuminates when the unit is injecting nitrogen into the workspace chamber. The Air Injecting light activates when outside air is being injected to raise the oxygen concentration in the chamber.

The N<sub>2</sub> solenoid operation is normally accompanied by a clicking sound. The air pump creates a slight buzzing.

### SET CO<sub>2</sub>%

5.0

This display shows the oxygen concentration in the workspace chamber as a percentage of the chamber atmosphere between 0 and 25%. The **UP / DOWN** arrow buttons are used to input an O<sub>2</sub> concentration set point for the workspace chamber atmosphere between 0.5 and 20% and to enter calibration offsets.



LED lamps and an audible buzzer alarm signal gas concentration deviations of  $\pm 1\%$  from the CO<sub>2</sub> set point. The yellow LED marked MUTE illuminates whenever an audible CO<sub>2</sub> deviation alarm is being muted. There is a 15-minute delay for the activation of the low deviation buzzer alarm.

### CO<sub>2</sub> Injecting



Marked CO<sub>2</sub> INJECTING, the light illuminates whenever the CO<sub>2</sub> solenoid is injecting CO<sub>2</sub> into the workspace chamber. CO<sub>2</sub> solenoid operation is normally accompanied by a clicking sound.

## Pass Box Switch and Chamber Light



### Start Pass Box Purge

This switch initiates an approximately 45-second cycle of the pass box. The cycle purges oxygenated atmosphere by injecting nitrogen into the box chamber and forcing oxygenated atmosphere out through a vent on the back of the unit.



### Pass Box Purging

This clear light illuminates for the duration of a pass box purge cycle.



### Lights

Turns the workspace chamber lights on and off.





## *THEORY OF OPERATION*

Standard sea level atmosphere has an oxygen concentration approximately 20.7%. The BACTROX can achieve a range of O<sub>2</sub> concentrations from 0.5 to 20% in its workspace chamber. The high end of the operating range is dependent on the amount of O<sub>2</sub> available in the ambient atmosphere. Additionally, the chamber atmosphere can be enriched with a CO<sub>2</sub> concentration of 1 – 20% when connected to a CO<sub>2</sub> supply source.

The unit is equipped with arm ports and an airlock-style pass box. These allow samples and equipment to be introduced to, manipulated in, and removed from the chamber without compromising the hypoxic atmosphere. The chamber is provided with a cabinet-style incubator for hypoxic culturing or cultivation applications.

### **Creating and Maintaining Hypoxic Conditions**

The BACTROX achieves low-oxygen conditions through pulsed injections of gas nitrogen (N<sub>2</sub>). This forces standard aerobic atmosphere out through a vent located on the chamber back wall. If the O<sub>2</sub> concentration fall below the user-programmed set point, the BACTROX injects oxygenated atmosphere drawn from the surrounding laboratory air.

Maintenance of the O<sub>2</sub> and CO<sub>2</sub> set points is a dynamic competition of N<sub>2</sub> and air injections, as well as CO<sub>2</sub> injections. When the chamber is sitting sealed and undisturbed, N<sub>2</sub> injections take place approximately every 4 – 6 seconds.

Pass box operations or a user working with arms in the chamber displace hypoxic atmosphere. This results in increased N<sub>2</sub> and CO<sub>2</sub> usage. Proper arm port entry and exit techniques, slow, deliberate movements while working in the chamber, and minimizing pass box usage can significantly reduce the displacement of hypoxic atmosphere.

The BACTROX microprocessor controller employs proportional-integral-derivative analytical feedback-loop functions when measuring and controlling gas levels. PID-controlled gas injection lengths are proportional to the difference between the measured chamber gas concentration and the current set points. The frequency of injections is derived from the rate of change in the difference. Gas injections slow as the chamber atmosphere nears the set points to avoid overshoots.



## Sensing Oxygen

The BACTROX detects the concentration of oxygen in the chamber atmosphere using the black and silver O<sub>2</sub> sensor located on the left chamber wall. The O<sub>2</sub> sensor operates with an internal temperature of 700°C to produce mobile oxygen ions through disassociation. The volume heated to temperature is very small.

The ions are drawn into sensor cavities separated by porous sheets of platinum-coated zirconium dioxide that act as an electrolyte. The controller determines the partial pressure of oxygen by measuring the voltage potential differential between ions separated by the zirconium sheets. That measurement is then compared with reference differentials that were saved in the controller memory during the previous O<sub>2</sub> sensor calibration. The controller derives the O<sub>2</sub> concentration from the measured partial pressure of oxygen (PPO).

**The sensor must be allowed five minutes to warm up to its operating temperature in order to provide an accurate O<sub>2</sub> measurement.**

Each BACTROX is shipped with the sensor calibrated for a two-point curve using a reference mixture of 5% O<sub>2</sub> – 95% N<sub>2</sub> for the low end. An ambient air sample drawn at near sea level with a calculated concentration is used for the high end.

The O<sub>2</sub> sensor comes set with a measurement range of 0 – 25% O<sub>2</sub> concentration. Control panel display readings above 25% indicate the display is out of calibration. The chamber has an effective operating range of 0.5 – 20%. The manufacturer cannot guarantee a stable oxygen concentration at settings above 20% due to the variability of ambient oxygen to draw on, as well as significantly increased wear on the air motor pump when running near continually to maintain an ambient atmosphere in a sealed chamber containing metabolically active samples.

## Sensing Carbon Dioxide

The BACTROX monitors CO<sub>2</sub> levels with an infrared sensor. The sensor operates on the principle that a band of infrared light is absorbed by CO<sub>2</sub>. The higher the CO<sub>2</sub> concentration in the chamber atmosphere, the more of that band of infrared is absorbed. This means that sensor is only sensitive to CO<sub>2</sub>, so measurement accuracy is consistent, regardless of the presence of other gases in the chamber. The addition of CO<sub>2</sub> to the chamber atmosphere is purely optional and dependent on your laboratory protocol and application requirements.

## Accessing the Chamber

Items such as media containers and laboratory equipment can be introduced to or removed from the hypoxic workspace chamber through the pass box. The pass box runs a user-initiated 45-second nitrogen purge that forces oxygenated room atmosphere out of the pass box chamber through a valve on the back of the unit.

Users can access and work glove-free in the workspace chamber by donning the sleeves attached to the front panel arm ports and entering through the ports. Effective use of the sleeves requires bare skin contact between the widest part of the user's forearms and the cuff ring of the sleeve assembly. Smooth, small items held in hand may be introduced into the workspace chamber through the sleeve assemblies.

The arm port sleeves are compatible with exam gloves for handling pathogenic samples inside the workspace.

## Incubator

When powered, the chamber incubator heats to and maintains a user-selected target set point in the incubation chamber. The unit senses the incubator temperature using a solid-state probe. When the unit detects that the incubator temperature has dropped below the target set point, it pulses power to the heating elements inside the chamber walls and floor.

The incubator uses Proportional – Integral – Derivative (PID) control to avoid significantly overshooting the temperature set point. This means the rate of heating slows as the incubator temperature approaches the target temperature. If the chamber temperature is above the set point, the incubator uses minimum heating to control the rate of cooling and avoid dipping below the set point.

Additionally, the PID loops optimize heating rates to compensate for the temperature environment around the unit. If the unit is operating in a cool room, it will increase the length of heating pulses to compensate. Likewise, when operating in a warm room the incubator uses shorter pulses. If the ambient temperature conditions change significantly, there may be minor over or undershoots as the incubator adapts.

The incubator relies on natural heat radiation for cooling and can achieve a low-end temperature just above the ambient room temperature plus the internal waste heat of the unit.

## The Over Temperature Limit System (OTL)

The OTL is a user-set, mechanical heating cutoff connected to a hydrostatic sensor probe inside the incubator. The system operates independently of the main microprocessor temperature controller and routes power away from the incubator heating elements if the chamber temperature exceeds the OTL temperature cutoff setting. It will continue doing so as long as the chamber temperature remains above the OTL setting. This helps safeguard the unit by preventing runaway heating in the event of electronics failures or a sudden external heat spike.

**The OTL must be set by the user in order to function.** The manufacturer recommends a setting of approximately 1°C above the highest temperature set point of your heating application. A red indicator illuminates when the OTL is rerouting power.

## Com Port Data and Logging Outputs

The BACTROX comes with an RS232 data port and generates three outputs once per minute as a logline describing the oxygen, CO<sub>2</sub>, and temperature levels. These outputs can be logged using a computer or building management system connected to the RS232 port. Please see the [Data Output and Logging](#) entry on page 47 for a more detailed description.

## Condensation Management

Petri plates and other open or breathable containers loaded with samples can generate significant humidity. This can lead to condensation in the workspace chamber if unchecked. To control humidity levels, the BACTROX is provided with a Peltier effect condensate chiller located behind a circulation fan on the upper left side of the workspace chamber.

Chamber humidity is trapped on the chiller's cold plate in the form of condensate. The condensate is then channeled into a drain tube that empties into a receptacle placed in the workspace chamber by the end-user. The receptacle must be regularly drained. The condensate chiller and its circulation fan eliminate the need to use chemical desiccants to control humidity level. Desiccants can dry out culture media while leaving significant condensate untouched.

The condensate chiller is active whenever the BACTROX is powered.

## *PUT THE BACTROX INTO OPERATION*

After the BACTROX has been installed in a new workspace, approximately 3 hours of work are required to put it into operation. However, **the manufacturer strongly recommends allowing 24 hours** for the chamber incubator to heat and stabilize and for the hypoxic atmosphere to stabilize prior to loading samples in the chamber.

Perform the following procedures in this chapter to put the unit into operation:

- ✓ **Power the BACTROX** – page 37
- ✓ **Establish a Hypoxic Atmosphere** – page 37
- ✓ **Set the Incubator Temperature** page – 40
- ✓ Read **Chamber Entry** – page 40
- ✓ Read **Chamber Movement Techniques** – page 41
- ✓ Read **Exit the Chamber** – page 42
- ✓ Read **Operation of the Pass Box** – page 44
- ✓ **Set the Over Temperature Limit** – page 45
- ✓ **Load the Chamber** – page 46

**Audible gas and temperature deviation buzzer alarms may sound** while the BACTROX is establishing a hypoxic chamber atmosphere and the incubator is heating to the set point.

To mute these alarms:

- Press the up or down arrow button on each control on which a red deviation indicator is illuminated.
  - Hold the button down until the yellow MUTE indicator illuminates.
- All active alarms must be muted before the buzzer will shut off. There is a 15-minute delay for the activation of audible low deviation alarms.

# OPERATION

## TURN ON THE BACTROX

1. Plug the female end of the power cord into the inlet on the back of the unit.
2. Plug the male end of the power cord into a suitable earth-grounded outlet.



3. Turn the power switch ON ( I ) to verify that the chamber will power up.





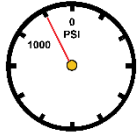
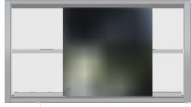
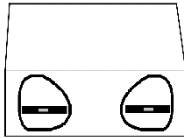
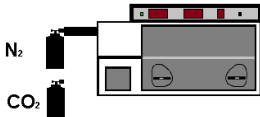

**Note:** The O<sub>2</sub> display will initially show fluctuating oxygen levels. It takes approximately 5 minutes for the Oxygen gas sensor probe come up to operating temperature.

## ESTABLISH A HYPOXIC ATMOSPHERE

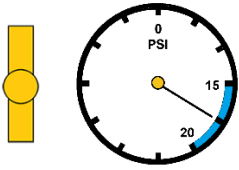
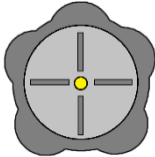





This procedure requires 1 to 3 hours depending on the gas concentrations to be achieved.

- Under normal conditions, 1.5 to 2 hours are required to achieve an O<sub>2</sub> concentration of 1%. It may take up to 4.5 hours to achieve a 5% CO<sub>2</sub> concentration in the chamber.
- Approximately **400 lb of N<sub>2</sub> tank pressure from a size 300 cylinder are required for a purge**, though this will be reduced if CO<sub>2</sub> is also being used.

<ol style="list-style-type: none"><li>1. Record the supply readings on the gauges of the gas sources. This is done to start a record of gas usage.</li></ol>	 <p>Supply Reading</p>
<ol style="list-style-type: none"><li>2. Verify that both incubator doors are open to avoid leaving a reservoir of fully aerobic atmosphere in the workspace chamber.</li></ol>	
<ol style="list-style-type: none"><li>3. Verify the arm port doors are closed and sealed.</li></ol>	 <p>Arm Ports Secured</p>
<ol style="list-style-type: none"><li>4. Verify that all gas supply sources are connected to the BACTROX.</li></ol>	 <p>N<sub>2</sub> CO<sub>2</sub></p>

Establishing a hypoxic atmosphere continued	
<p>5. Verify the gas supply regulators are set to deliver 15 to 20 psi of gas flow pressure at the BACTROX gas in ports.</p> <ul style="list-style-type: none"> <li>Do not exceed 20 PSI for either supply source.</li> </ul>	<p style="text-align: center;"><b>N<sub>2</sub> and CO<sub>2</sub></b></p> 
<p>6. Open the gas supply valves all the way to supply gas to the BACTROX.</p> <ul style="list-style-type: none"> <li>Do so for both the N<sub>2</sub> supply and any optional CO<sub>2</sub> gas supply</li> </ul>	 <p style="text-align: center;"><b>N<sub>2</sub> and CO<sub>2</sub></b></p>
<p>7. <b>Set the oxygen set point</b> to your required application or study O<sub>2</sub> level.</p> <div style="display: flex; flex-direction: column; gap: 10px;"> <div style="display: flex; align-items: center;">  <div style="margin-left: 10px;">a. Push either of the arrow buttons and then release.</div> </div> <div style="display: flex; align-items: center;">  <div style="margin-left: 10px;">b. The display will briefly flash the letters "SP" for set point, then switch from bright to dim and blink on and off.</div> </div> <div style="display: flex; align-items: center;">  <div style="margin-left: 10px;">c. Use the up and down arrow buttons to adjust the set point to your required O<sub>2</sub> concentration.</div> </div> <div style="display: flex; align-items: center;"> <div style="margin-right: 10px;">Wait 5 Seconds</div> <div style="margin-left: 10px;">d. After adjusting the display to your application or process set point, wait 5 seconds.</div> </div> </div> <ul style="list-style-type: none"> <li>• The display will cease flashing and brighten. The set point has been saved.</li> <li>• The BACTROX will now begin injecting N<sub>2</sub> to create a hypoxic atmosphere.</li> </ul>	<p style="text-align: center;"><b>SET OXYGEN %</b></p>  <p style="text-align: center;"><b>SET OXYGEN %</b></p>  <p style="text-align: center;">15% example</p>

Continued on next page

Establishing a hypoxic atmosphere continued	
<p>8. <b>Optional:</b> Set a CO<sub>2</sub> set point.</p> <div style="display: flex; flex-direction: column; align-items: flex-start;"> <div style="margin-bottom: 10px;">  </div> <div style="margin-bottom: 10px;">  </div> <div style="margin-bottom: 10px;">  <p>Wait 5 Seconds</p> </div> </div> <ol style="list-style-type: none"> <li>a. Push either of the arrow buttons and then release.</li> <li>b. The display will briefly flash the letters "SP" for set point, then switch from bright to dim and blink on and off.</li> <li>c. Use the up and down arrow buttons to adjust the set point to your required O<sub>2</sub> concentration.</li> <li>d. After adjusting the set point to your application or process set point, wait 5 seconds.             <ul style="list-style-type: none"> <li>• The display will cease flashing and brighten. The set point has been saved.</li> <li>• The BACTROX will now begin injecting CO<sub>2</sub> to enrich the chamber atmosphere.</li> </ul> </li> </ol>	<p><b>SET CO<sub>2</sub> %</b></p>  <p><b>SET CO<sub>2</sub> %</b></p>  <p>5% Example Value</p>
<p>9. Do not enter the workspace chamber or use the pass box while the BACTROX is purging the chamber atmosphere.</p>	
<p>10. <b>Optional:</b> Set the incubator temperature set point while waiting for the hypoxic atmosphere to be established.</p> <ol style="list-style-type: none"> <li>a. Please see the Set the Incubator Temperature procedure on the next page.</li> </ol>	<p><b>Optional</b></p> <p><b>Set the Incubator Temperature</b></p> <p>Page 40</p>
<p>11. End states. <b>A hypoxic atmosphere has been achieved when:</b></p> <ol style="list-style-type: none"> <li>a. The SET OXYGEN % display has stabilized for 1 hour without any changes at your O<sub>2</sub> set point.</li> <li>b. <b>Optional:</b> The SET CO<sub>2</sub> % display has stabilized without any changes for 1 hour at or near your CO<sub>2</sub> set point.</li> </ol>	

End of procedure

## SET THE INCUBATOR TEMPERATURE

Close the incubator doors prior to setting a temperature set point. Running the incubator with the doors open for longer than 30 minutes will result in temperature instability and overshoots after the doors are closed.

### 1. Set OTL control to its maximum setting, if not already set to max.

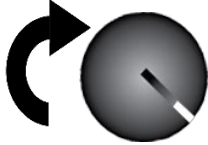

- Turning the OTL all the way to the right (clockwise) prevents the heating cutoff system from interfering with this procedure.

### 2. Switch to the Temperature Set Point Adjustment mode



Press and hold either

Set Temperature

SP

Set Point Adjustment Mode

Set

OFF

Initial Set Point

**Note:** The display will automatically exit the adjustment mode after 5 seconds of inactivity on the arrow buttons, saving the last shown set point value.

### 3. Set the Temperature Set Point



Adjust

37.0

New Set Point

**Note:** To turn an incubator off, set the set point to its lowest setting (OFF).

### 4. Wait for 5 seconds after entering the Set Point



Wait 5 Seconds

Set Temperature

35.6



HEATING ACTIVATED

- The display will stop flashing. The set point is now saved in the controller.
- The display will revert to showing the current chamber air temperature. The unit will heat or passively cooling to match the new set point.

End of procedure



# OPERATION

**Note:** Familiarize yourself with the chamber entry and exit procedures and movement techniques prior to entering a hypoxic chamber.

## CHAMBER ENTRY

Prior to entry, read the **Exit the Chamber procedure** (page 42) for how to withdraw your arms from the chamber without compromising the hypoxic atmosphere.

### 1. Don the Sleeves

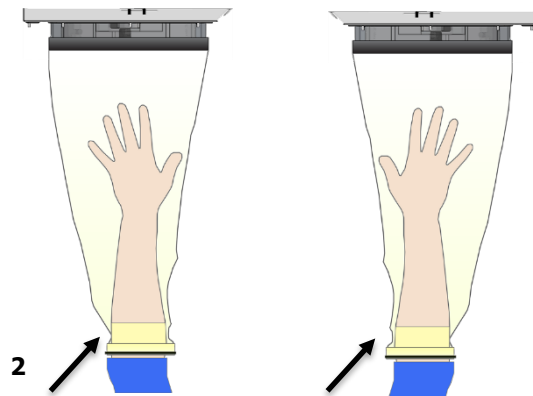

Remove rings and watches.  
Sharp objects will damage the

Snug contact, sleeve cuff and bare skin at the widest part of the forearm.

### 2. Open the Arm Port Doors

a.



- Loosen both arm port doorknobs by 2 or 3 turns.

b.



- Rotate the locking bars to roughly 45° diagonals.

c.

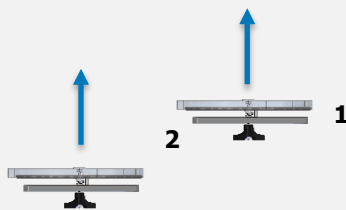

- Slowly push one door into the chamber, then the second.
- Pushing both doors in simultaneously will create a significant displacement of pressurized chamber atmosphere, resulting in active venting.

### 3. Stow the Doors



- Place both doors in the stowage racks on the bottom of the incubator.

## CHAMBER MOVEMENT TECHNIQUES

Reaching into the chamber through the arm ports creates pressure as the user's arms displace hypoxic atmosphere. This generates mechanical resistance and may force some hypoxic atmosphere out through the filtered exhaust vent. Exhausting prevents damage to the BACTROX from overpressure.

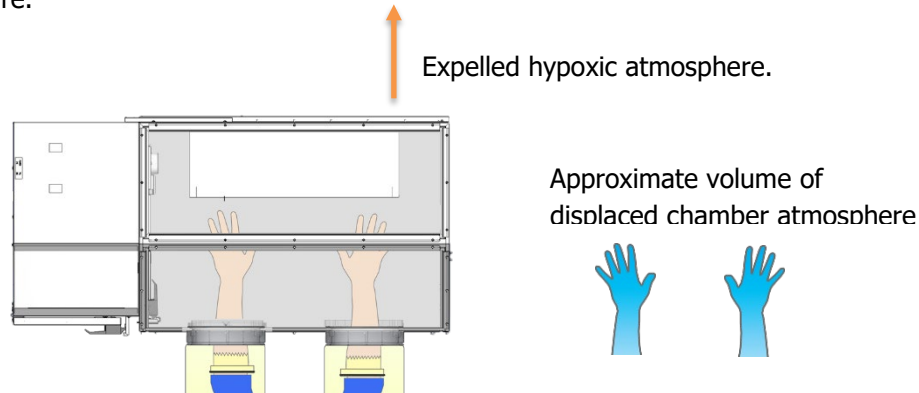

Use the following techniques to reduce displacement and gas usage while working in the chamber.

1. Avoid making fast or large movements while working in the chamber.
2. Use a swimming motion, withdrawing one arm partly into the arm port while reaching in with the other.

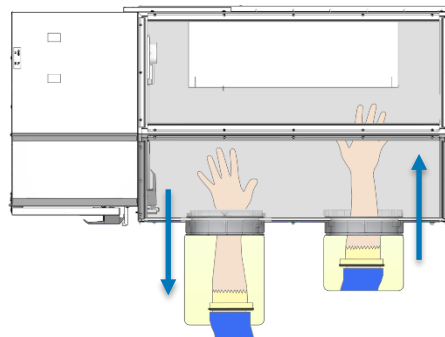

- Placing only one arm all the way in the chamber reduces the volume of displaced atmosphere.

## EXIT THE CHAMBER

Pressure in the chamber drops when a user withdraws their arms. If done too quickly, this can draw in outside air through the sleeve cuffs or exhaust vent. Use the following steps to exit the chamber without pulling in aerobic atmosphere.

1. Check that both pass box doors are closed and latched to avoid drawing aerobic atmosphere in through the box.
2. One at a time, remove the arm port doors from stowage and place them on the chamber floor in front of the ports.
3. Close and latch the arm port doors.

- a. See the Install the Arm Port Doors procedure on page 23 for how to correctly latch the arm port doors.
4. Withdraw your arms from the sleeves one at a time.

## OPERATING THE PASS BOX

### Introducing Items

1. Make sure the inner pass box door is closed and secured.
2. Open the outer pass box door.
3. Load the pass box sliding shelf with items to be introduced in the workspace chamber.
4. Close and secure the outer door.
5. Push and immediately release the **Start Pass Box Purge** switch. Do not hold down the switch.
6. The purge cycle runs for 45 seconds.
  - a. N<sub>2</sub> is injected into the pass box, and oxygenated atmosphere evacuated through a vent on the back of the unit.
  - b. The white **Pass Box Purging** light will flash throughout the cycle.
7. Once the purge cycle is complete you may open the inner pass box door and pull the sliding shelf into the workspace chamber.



**Pass Box**

**Best Practice.** Stow the sliding shelf in the pass box and close the inner pass box door once the shelf has been unloaded. This protects accidental exposure of the workspace chamber to fully aerobic atmosphere if the outer pass box door is opened while the inner door is still open.

**Aborting:** To abort a pass box purge cycle, press and hold the **Start Pass Box Purge** switch for **five (5) seconds**. The purging light will cease flashing and turn off. The cycle is now terminated.

### Removing Items

1. Make sure the outer pass box door is closed and secured.
2. Open the inner pass box door.
3. Pull the pass box sliding shelf into the chamber and load with items to be removed.
4. Return the shelf to the pass box. Close and secure the inner door.
5. Push and immediately release the **Start Pass Box Purge** switch. Do not hold down the switch.
6. The purge cycle runs for 45 seconds.
  - a. The white Pass Box Purging light will flash throughout the cycle.
7. Once the purge cycle is complete, you may open in the outer pass box door and unload the pass box shelf.

**Note:** Test the OTL system at least once per year for functionality.

## *SET THE OVER TEMPERATURE LIMIT*

The incubator must be operating at your incubation application temperature and must be stable for at least 1 hour prior to setting the OTL.

**1. Set OTL control to its maximum setting,** if not already set to max.

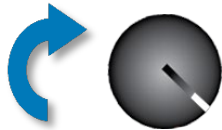

**2. Turn the dial counterclockwise until the red Over Temperature Limit Light illuminates.**



**3. Slowly turn the dial clockwise until the OTL Activated light turns off.**



- The Over Temperature Limit is now set approximately 1°C above the current incubator air temperature.

**4. Leave the OTL dial set just above the activation point.**



**Optional: Turn the dial slightly to the left (counterclockwise).**



- This sets the OTL cutoff threshold nearer to the current incubator air temperature.

If the OTL is sporadically activating, you may turn the dial very slightly to the right (clockwise).

If the OTL continues activating, check for ambient sources of heat or cold that may be adversely impacting the unit temperature stability. Check if any powered accessories in the workspace chamber are generating heat. If you can find no sources of external or internal temperature fluctuations, contact Tech Support or your distributor for assistance.

End of Procedure

## *LOADING SAMPLES*

The manufacturer recommends waiting 24 hours after establishing an hypoxic atmosphere before loading samples into the unit.

### **Containers**

Airtight containers can introduce significant amounts of oxygen into the hypoxic workspace chamber.

- Whenever possible, closed containers placed in the pass box should be loose-capped or ventilated to allow the pass box cycle to draw oxygen from the containers.
- Caps on empty syringes should be loosened if permitted by your laboratory or production protocol.

### **Sliding Shelf Transport**

The pass box sliding shelf can hold and transport up to 78 plates.

### **Incubator Sample Placement**

- Even spacing: Place samples and other media containers as evenly spaced as possible on the incubator shelves. This allows for atmosphere circulation and better temperature uniformity.
- If samples sensitive to heat are being cultivated, it may be necessary to place an empty Petri plate at the bottom of each stack of the workspace incubator.

## *HUMIDIFYING THE INCUBATOR*

Placing a small number of Petri dishes or other open media containers in the incubator for several weeks may lead to excessive drying of sample media. A small open container such as a flask, of 500ml of distilled water, set on each shelf of the incubator can help to slow sample drying.

## *GAS CONSERVATION METHODS*

1. Minimize the number of times per day the pass box is purged and opened.
2. Introduce small individual items, such as sealed microplates or transport tubes, into the workspace chamber through the sleeve assemblies.

## *CHAMBER POWER OUTLET*

BACTROX-2 chambers are provided with a 1-amp accessory outlet located inside the workspace chamber, on the left wall. The power switch on the main control panel controls power to the outlet. The outlet can power equipment such as magnetic stirrers or a volatile compounds scrubber fan. Do not attach equipment drawing more than one (1) amp.

Accessory equipment may produce additional heat in the workspace chamber. This can affect the temperature range of the incubator. Monitor the incubator performance when using powered accessories inside the workspace chamber.

## *DATA OUTPUTS AND LOGGING*

Each BACTROX hypoxia chamber is provided with an RS232 DB9 com port, an RS232 cable, and an RS232 to USB Type A adaptor. While the com port and cable are primarily intended for use in calibrating the oxygen sensor, the com port may also be used for data logging. Once per minute the BACTROX will send three outputs through the com port describing the current **temperature** (°C), **oxygen** (O<sub>2</sub>), and **carbon dioxide** (CO<sub>2</sub>) levels in the workspace chamber.

Use of the cable and com port requires downloading and installing the free, open source (**BSD license**) Tera Term terminal emulator on a laptop or other device. Tera Term can be downloaded from the **Tera Term development** project site (SourceForge.JP) at:

<http://en.sourceforge.jp/projects/ttssh2/releases/>

### **Using the RS232 to USB adaptor**

RS232 uses a communications protocol different from that of USB, and the adaptor requires its own driver to convert between the two protocols. These drivers are available for free download on the adaptor manufacturer's website. Choose one compatible with your computer operating system.

<http://www.iogear.com/support/dm/driver/GUC232A>

#### Logging Channels:

C1 = Current  
Temperature

C3 = Current  
Oxygen

C4 = Current  
CO<sub>2</sub>

The BACTROX will not be able to communicate with a computer via the USB adaptor without a driver.









See pages 67 – 68 in the O<sub>2</sub> Calibration procedure for instructions on how to connect the BACTROX to a logging computer and how to initiate the logging process.



## ADJUST THE GAS SET POINTS

This procedure works for changing both the O<sub>2</sub> and CO<sub>2</sub> set points.



<div style="display: flex; align-items: center;">   </div> <ol style="list-style-type: none"> <li>Briefly push either of the arrow buttons on the control for the gas you wish to adjust, then release. <ul style="list-style-type: none"> <li>The gas display will briefly flash the letters "SP" for set point.</li> <li>This display will then switch from bright to dim and blink on and off. This is the adjustable set point.</li> </ul> </li> </ol> <p><b>Note:</b> After 5 seconds of inactivity the display will exit the set point mode, saving the last shown value as the new set point.</p>	 <p style="text-align: center;"><b>Set Point</b></p>  <p style="text-align: center;"><b>Current Set Point</b></p>
<div style="display: flex; align-items: center;">   </div> <ol style="list-style-type: none"> <li>Use the up and down arrow buttons to adjust the set point to the new gas concentration.</li> </ol>	 <p style="text-align: center;"><b>New Set Point</b></p>
 <p>Wait 5 Seconds</p> <ol style="list-style-type: none"> <li>Wait 5 seconds after entering the new set point. <ul style="list-style-type: none"> <li>The display will cease flashing, then brighten.</li> <li>The set point has now been entered into the BACTROX, and the chamber will now begin to adjust to the new set point.</li> </ul> </li> </ol>	 <p style="text-align: center;"><b>Chamber Adjusting</b></p>

End of Procedure

## MUTE THE AUDIBLE O<sub>2</sub> / CO<sub>2</sub> ALARMS

Visual deviation alarm indicators for O<sub>2</sub> or CO<sub>2</sub> illuminate if a gas level deviates 1% above or below the current set points. An audible alarm for each gas type sounds immediately for high deviations. There is a 15-minute delay for low deviation audible alerts. This prevents the alert from sounding in the event a chamber entry creates a short-lived drop in gas concentration.



**Alarm Muted**

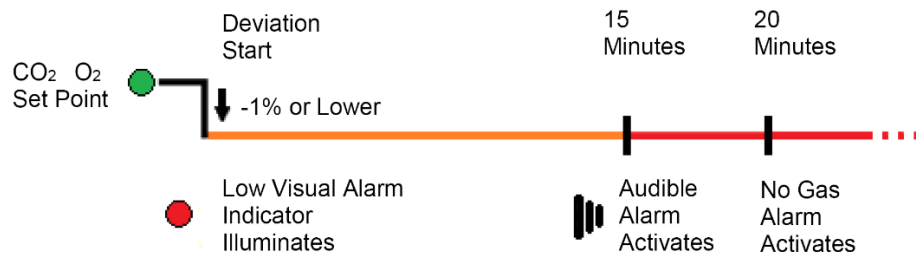

**Gas Alarms Timeline**

To mute:

1. Press and hold the **Up** or the **Down** arrow button for 1 second on the control with the illuminated alarm indicator.
  - a. The alarm will cease sounding and the yellow Mute indicator light will illuminate.



The alarm will stay muted for the duration of the **current** temperature deviation. Another deviation of 1% will reactivate the audible alarm.

## *ACTIVATED CARBON SCRUBBER AND REJUVENATION CYCLE*

Activated carbon scrubber media may be placed in the workspace chamber to absorb volatile fatty acids or volatile sulfur compounds produced by sample cultivation. This helps keep the chamber interior clean and may help reduce sulfur odors.

See the [Accessories section](#) on page 99 for scrubber media and a volatile compounds scrubber fan description.

1. The recommended use is 250 grams (one packet) placed in a 500ml beaker inside the chamber. Place another 250 grams into a second 500ml beaker.
2. On day 2 replace the first beaker of charcoal scrubber with the second.
3. On day 3 reactivate the first beaker of charcoal scrubber by heating at a minimum of 160°C for at least 2 hours.
  - a. Place the reactivated scrubber in the chamber. Remove and reactivate the second scrubber.
  - b. For best effect, reactivate the scrubber by heating overnight.
4. Repeat this cycle for 6 months. Discard both scrubbers after six months and replace.

## Chamber Quality Control Check Sheet

Month :					
Date:	Incubator Temperature	Condensate Drained	N <sub>2</sub> Cylinder Pressure Reading	CO <sub>2</sub> Cylinder Pressure Reading	
1					
2					
3					
4					
5					
6					
7					
8					
9					
10					
11					
12					
13					
14					
15					
16					
17					
18					
19					
20					
21					
22					
23					
24					
25					
26					
27					
28					
29					
30					
31					

--	--	--	--	--	--

*You may copy this sheet for institutional use*

## *DAILY MAINTENANCE*

1. Record the gas supply reading(s) to track usage.
2. Change the gas cylinder(s) if low.
3. Remove and drain the condensate collection container as needed.
4. Visually inspect that the pass box gaskets are properly seated.
5. Check the cuffs on the sleeve system for holes, tears, and other signs of wear that may compromise integrity. Replace if necessary.
6. Check the incubator temperature to ensure that the setting is correct.
7. Change or reactivate the charcoal scrubber, if installed. Please see the [Activated Charcoal Scrubber and Rejuvenation Cycle](#) on page 52 in the Operation section.
8. Clean and disinfect the workspace chamber in accordance with your laboratory or production protocols, or regulatory requirements.

## *DOOR GASKET MAINTENANCE AND USAGE*

BACTROX door gaskets are consumable items. Replace when the gasket shows obvious signs of wear or damage such as dryness, brittleness, cracks, or tears. Heavy institutional users may wish to keep a pair of spare door gaskets on hand (Part Number 3450507).

Spilling sample media on door gaskets or the interior surfaces of pass box doors may cause the gaskets to stick to the doors.

- This can compromise the atmospheric integrity of the pass box when door openings pull sticky gaskets off the mounting rails.
- Gaskets can be cleaned with dish soap and warm water, if compatible with your laboratory protocol.

## *SLEEVES MAINTENANCE AND USAGE*

The arm port sleeves may be washed with dish soap and warm water between uses. Disinfection should be carried out per lab protocols. Institutions with several users for each BACTROX may wish to keep a pair of sleeves in small, medium, and large sizes on hand. Or keep a pair of sleeves for each user.

The sleeve cuffs are subject to the most wear on the sleeve assemblies. The manufacturer recommends keeping a stock of replacements on hand. See the [replacement parts list](#) starting on page 93 for sizes and part numbers of latex and nitrile cuffs. Make sure that the cuff matches the size of the sleeve assembly it will be attached to.

Sleeves or cuffs should be replaced when brittleness, dryness, or cracks are present.

## REPLACING THE SLEEVE CUFFS

### Disassembling the Sleeves

1. Roll the black O-ring off the cuff on the outside of the sleeve assembly.
2. Pull the sleeve cuff and cuff-ring out of the sleeve body.
3. Remove the 2<sup>nd</sup> black O-ring.
4. Remove the sleeve cuff from the cuff-ring.
5. Inspect all components for brittleness, dryness, holes, or cracks. Replace as needed.
  - The cuffs have the fastest rate of wear.

### Reassembling the Sleeves

1. Pull the wide, fringed side of the sleeve cuff on over the cuff-ring.
2. Roll an O-ring onto the cuff-ring, over the sleeve cuff. Place the ring into the groove opposite the fringed side of the cuff.
3. Pull the narrow end of sleeve body over the sleeve cuff and cuff-ring. The fringed end of the sleeve cuff should be inside the sleeve body, and the body of the cuff should protrude from the sleeve.
4. Roll on the second O-ring. Place the O-ring into the unoccupied cuff-ring groove.

End of Procedure

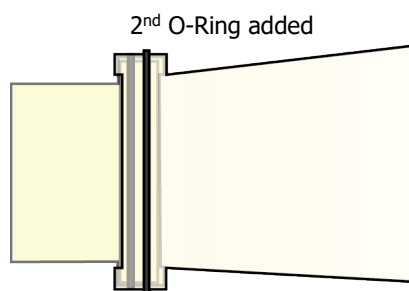
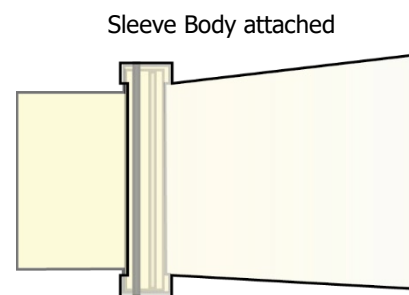
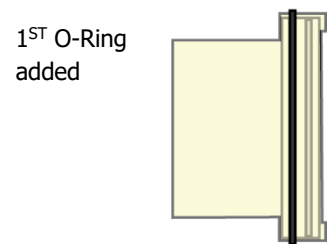
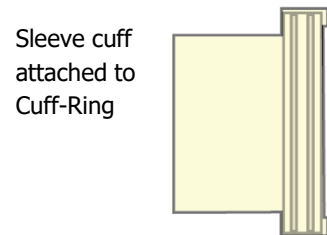
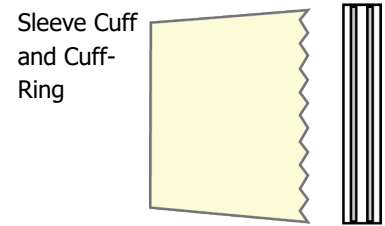





**Warning:** Disconnect this unit from its power source prior to maintenance or cleaning.

**Avertissement:** Avant tout entretien ou nettoyage de cet appareil, débranchez le cordon d'alimentation de l'alimentation.

## *CLEANING AND DISINFECTING*

If a **hazardous material or substance** has spilled in the unit, immediately initiate your site Hazardous Material Spill Containment protocol. Contact your local Site Safety Officer and follow instructions per the site policy and procedures.

- The BACTROX should be cleaned and disinfected prior to first use.
- Periodic cleaning and disinfection are required to prevent microbiological contamination.
- Do not use spray-on cleaners or disinfectants. These can leak through openings and coat electrical components.
- Do not use cleaners or disinfectants that contain solvents capable of harming paint coatings, acrylic glass, or stainless steel surfaces. **Do not use chlorine-based bleaches or abrasives—these will damage the chamber liner.**
- Consult with the manufacturer or their agent if you have any doubts about the compatibility of decontamination or cleaning agents with the parts of the equipment or with material contained in it.



**Warning:** Exercise caution if cleaning the unit with alcohol or flammable cleaners. Always allow the unit to cool down to room temperature prior to cleaning and make sure all cleaning agents have evaporated or otherwise been completely removed prior to putting the unit back into service.

**Avertissement:** Soyez prudent lorsque vous nettoyez l'appareil avec de l'alcool ou des produits de nettoyage inflammables. Laissez toujours refroidir l'appareil à la température ambiante avant le nettoyage et assurez-vous que tous les produits de nettoyage se sont évaporés ou ont été complètement enlevés avant de remettre l'appareil en service.

## **Cleaning**

Keep the following in mind when cleaning the BACTROX interior.

- Remove and clean the sleeves and all removable workspace chamber accessory items.
- Wash the arm port doors, sample dish racks, shelf spacers, pass box gaskets, and sleeves with a mild soap and water solution.
- Clean the workspace chamber, incubator, and pass box interiors with a mild soap and water solution, including all corners.
  - Take special care when cleaning around and chamber power outlets to prevent damage. Do not clean the pass box door alarm sensors (see page 59).
  - Do not use chloride-based cleaners except Zephiran benzalkonium chloride solution. Other types may have adverse effects on microbiological samples.

- Rinse with distilled water and wipe dry with a soft cloth. Do not use deionized water. Please see page 21 for more information on DI water.
- Wipe down the interior surfaces with Zephiran. Allow the Zephiran to evaporate, do not wipe it up.

## Disinfecting

Keep the following points in mind when carrying out your laboratory, clinical, or production space disinfection protocol:

- Turn off the BACTROX to safeguard against electrical shocks.
- Disinfect the unit using commercially available disinfectants that are non-corrosive, non-abrasive, and suitable for use on stainless steel, painted surfaces, and acrylic glass. Contact your local Site Safety Officer for detailed information on the disinfectants compatible with your cultivation or culturing applications.
- Do not use overtly volatile disinfecting agents. Chlorines, amphyls, and quaternary ammonias will evaporate into the chamber environment. Concentration in the chamber atmosphere will increase over time, potentially leading to inhibited growth or metabolic symptoms in sample populations.
- Open all the BACTROX doors to facilitate disinfection, ventilation of disinfectants, and drying.
- If possible, remove all interior accessories (shelf spacers, Petri dish racks, and other non-attached items) from the chamber when disinfecting.
- Disinfect all corners of the workspace chamber, the incubator interior, and the pass box interior.
- Take special care not to damage the arm port door gaskets or the pass box door gaskets.
- After completion of your institutional protocol, allow all disinfectants to evaporate completely. Wipe down all surfaces except the door sensors with distilled water and Zephiran until the chamber no longer has a volatile odor. Use nonabrasive wipes.

**Pass Box Door Sensor, 1 per Door**

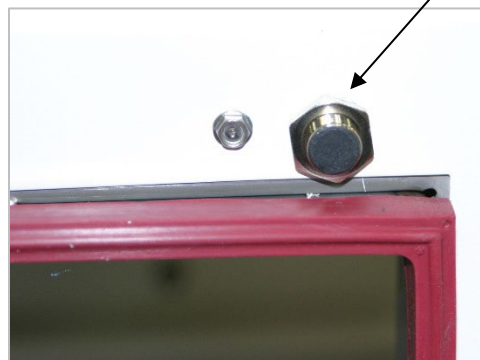

**Pass box Door Sensor**

## *MAINTAINING THE ACRYLIC GLASS PANELS*

### **Cleaning and Scratches**

The manufacturer recommends using Novus brand acrylic glass cleaner and scratch remover for cleaning and maintaining acrylic glass surfaces on the BACTROX. Please see the [Accessories section](#) on page 99. Alcohol or alcohol-based solvents and other aggressive solvents should never be used to clean the BACTROX and may damage the acrylic glass panels.

### **Ultraviolet Lighting**

**Never expose the BACTROX to sustained UV light.** Prolonged exposure to UV will result in rapid aging of the acrylic glass, leaving it vulnerable to compression forces, and generating cracks across all exposed areas. UV light will also quickly age sleeve assemblies, turning the sleeves yellow and result in a quick loss of elasticity.

The BACTROX should not be exposed to direct sunlight.

Damage from exposure to ultraviolet light is not covered under the manufacturing defect warranty.

Disable or redirect laboratory disinfection UV lighting away from the BACTROX. Verify that your laboratory or workspace environment does not use UV disinfection lighting at night. This type of light is usually referred to as short-wave UVC or germicidal UV light and operates at roughly 254nm.

Periodic use of long-wave (365nm) UV hand lamps used for bacterial identification should not damage the acrylic glass.

## *ELECTRICAL COMPONENTS*

Electrical components do not require maintenance. If the electrical systems fail to operate as specified, please contact your BACTROX distributor or technical support for assistance.

## *CONDENSATION AND THE DEW POINT*

**Relative humidity inside the BACTROX should never exceed 80% at 25°C.** Exceeding this threshold will likely result in condensation on incubator and workspace surfaces.

Condensate will appear wherever the humidity level in the chamber reaches the dew point. The dew point is the level of humidity at which the air cannot hold more water vapor. The warmer the air, the more water vapor it can hold.

As the level of humidity rises in the chamber, condensate will first appear on surfaces cooler than the air temperature. Near the dew point, condensate will form on any item or exposed surface that is even slightly cooler than the air. When the dew point is reached, condensation forms on nearly all exposed surfaces.

Some condensate will be present in the BACTROX chamber if it is fully loaded or loaded to near capacity with open media plates, depending on ambient temperature and humidity. Cold air blowing on the exterior of the BACTROX may also help cause condensation in the workspace chamber by chilling the acrylic glass panels and metal bulkheads.

Managing excessive condensate at humidity levels that overwhelm the BACTROX condensate controller depends on either lowering the humidity level in the chamber or increasing its air temperature.

---

**Note:** Rising or falling air pressure from the weather will adjust the dew point up and down in small increments. If the relative humidity in the BACTROX is already near the dew point, barometric fluctuations may push it across the dew point threshold.

---

If excessive condensate is forming in the workspace chamber, check the following:

- Check to see if condensate from the condensate controller is draining through the drain tube in the left wall and into the collection vessel.
- Remove or cap open containers of water or media.
- Empty the condensate controller catch vessel frequently.
- Are there more than 300 plates in the workspace chamber? Reduce the number of sample containers.
- Does the ambient humidity in the room exceed the stated operating range of 80% relative humidity? If so, lower the room humidity.
- Is the BACTROX exposed to an external flow of cold air such as an air-conditioning vent or a door to a cooler hallway or adjacent room? Block or divert the air or move the unit.
- Verify that the circulation fan over the Peltier condensate controller on the left wall of the chamber is operating. The fan circulates air over condensate controller's cold plate.

**Note:** The O<sub>2</sub> sensor requires five minutes to warm up to its operating temperature in order to provide an accurate O<sub>2</sub> measurement. It will begin heating as soon as the BACTROX is turned on.

## *CALIBRATE THE O<sub>2</sub> SENSOR AND DISPLAY*

The oxygen calibration procedures verify the accuracy of the O<sub>2</sub> display and correct for any measurement errors. Errors accrue due to gradual material changes in the O<sub>2</sub> sensor because of a high internal operating temperature and exposure to ionized oxygen as well as other heated gases. Additionally, the sensor derives the O<sub>2</sub> concentration from the measured partial pressure of oxygen (PPO), so its measurements are sensitive to altitude and barometric pressure.

Each BACTROX is shipped from the factory calibrated at near sea level for a two-point curve using an N<sub>2</sub> – O<sub>2</sub> reference mixture of 5% O<sub>2</sub> for the low value and a near sea level ambient air sample of around 20.7% O<sub>2</sub> for the high value.

### **Recommended O<sub>2</sub> Calibrations**

- When preparing the unit for use at altitudes higher than 2000 feet (600 meters).
- As required by your laboratory, study or production protocol, or regulatory compliance schedule.

### **Chamber O<sub>2</sub> Deviations During Calibrations**

The O<sub>2</sub> controller is set to Off during calibration procedures. This means no N<sub>2</sub> or air injections take place. The oxygen concentration in the chamber may drift from the set point. Use proper entry and exit procedures when using the BACTROX arm ports to minimize disruptions to the hypoxic atmosphere during a calibration.

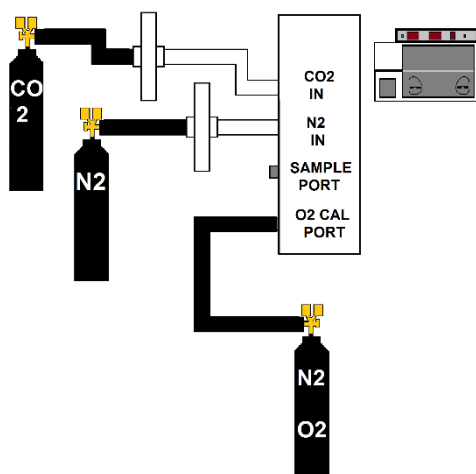

**Mixed Reference Gas Cylinder**

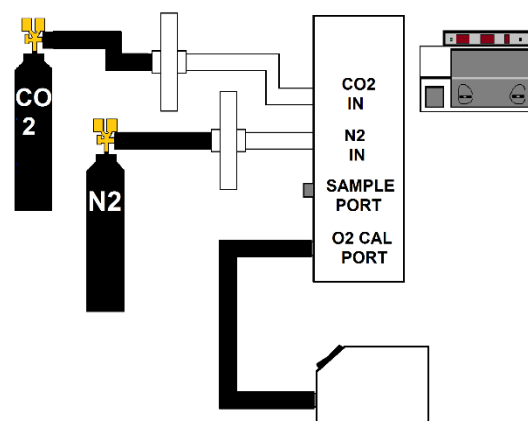

**Ambient Air Sample Pump**

## Sample Types

Two air sample types may be used for calibrations.

- A reference mixed gas cylinder with a known O<sub>2</sub> concentration
- An ambient air sample with a calculated O<sub>2</sub> concentration

**Reference gases:** These are typically a dry gas (no humidity) mix of nitrogen and a precise oxygen concentration. Reference gas mixes may be used for all calibration types.

**Ambient air sample:** The BACTROX may also be calibrated to an ambient air sample drawn from the laboratory environment. To use an ambient air sample, it is necessary to calculate the oxygen concentration value of the air using the current temperature, humidity, and barometric pressure. The temperature and humidity should be obtained using sensors inside the laboratory environment in the immediate vicinity of the BACTROX. The current barometric pressure may be obtained from a local meteorological service or online source **unless** the BACTROX is located in an overpressure or negative pressure environment. In an artificial pressure environment, the air pressure must be measured in the same room as the BACTROX.

Please see the [Calculating the O<sub>2</sub> Concentration procedure](#) on page 101 for the formulas used to calculate the current ambient O<sub>2</sub> concentration. The ambient sample should be obtained by attaching the air pump provided with the BACTROX-2 O<sub>2</sub> calibration kit to the BACTROX calibration port.

## Calibration Types

The BACTROX can be calibrated in one of two modes:

- Single Point Calibration
- Dual Point Calibration

### Single Point Calibration

The single point calibration procedure produces a calibration offset adjustment to match the sensor and its display to the calibration sample.

If a difference is detected between the sensor reading and the known or calculated value of the gas sample, an offset adjustment is entered into the BACTROX controller. **The single point calibration and should only be used in applications in which having an absolute linear curve throughout your range of chamber O<sub>2</sub> concentrations is not an issue.** This may mean that a single point O<sub>2</sub> calibration is only valid for a single O<sub>2</sub> chamber concentration for your study.



Reference Gas



Ambient Sample Air Pump

Required for the single point calibration procedure:

- An ambient air sample or a reference gas cylinder
- The O<sub>2</sub> calibration kit provided with the BACTROX



**Note:** The effective O<sub>2</sub> concentration operating range of the BACTROX is 1 – 20%.

**Note:** The links and sites listed below are provided as conveniences. Sheldon Manufacturing makes no warrant as to the safety of third-party sites, their contents, or the reliability or support of software products contained therein.



15% O<sub>2</sub>  
85% N<sub>2</sub>

## Dual Point Calibration

The dual point calibration procedure calibrates the sensor to an **upper calibration value point** and a **low calibration value point** to produce an adjusted linear curve across a range of potential chamber O<sub>2</sub> concentrations. The upper calibration may be made using either ambient laboratory atmosphere or a reference gas mix and should never exceed 20.7%. **The low value is always calibrated using a hypoxic reference gas cylinder.**

Required for the dual point calibration procedure:

- An ambient air sample **or** an oxygen reference cylinder for the upper calibration point.
- A hypoxic oxygen reference mixture for the low calibration point.
- A computer connected to the BACTROX using the RS232 cable provided with the unit (includes USB adaptor).
- A software driver for the USB adaptor compatible with your computer operating system. RS232 uses a communications protocol different from that of USB, and the adaptor requires its own driver to convert between the two protocols. These drivers are available for free download on the adaptor manufacturer's website:
  - <http://www.iogear.com/support/dm/driver/GUC232A>
- Terminal emulation software, such as, Tera Term, loaded on the computer (see below).
- The O<sub>2</sub> calibration kit provided with the BACTROX.



5% O<sub>2</sub>  
95%

## Dual Point O<sub>2</sub> Calibration Procedure



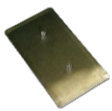

**Note:** Make sure the calibration kit cover plate is inside the workspace chamber prior to starting this procedure.

Prior to starting this procedure, install a terminal emulator on the computer you will be using for the calibration and data logging. There are several free, open source emulators available online. Sheldon Manufacturing uses Tera Term when performing dual point calibrations and data logging at the factory. Tera Term is a free (**BSD license**) software application that can be downloaded from the **Tera Term development** project site (SourceForge.JP) at:

<http://en.sourceforge.jp/projects/ttssh2/releases/>

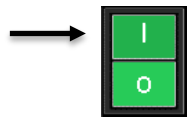

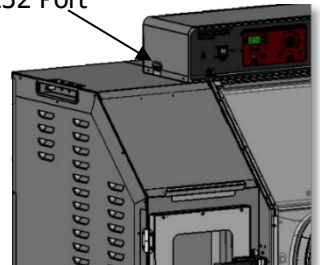
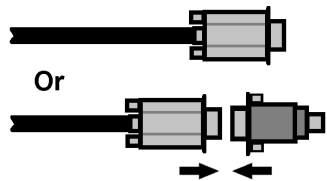
Continued on next page

Dual Point O <sub>2</sub> Calibration	
<p>1. If you will be using an ambient air sample for the upper-value calibration, calculate the current O<sub>2</sub> concentration of the ambient laboratory atmosphere.</p> <p>a. <math>WVP = \left(\frac{H_{rel}}{100}\right) \cdot WVP_{max}</math></p> <p>b. <math>PPO_2 = (BP - WVP) \cdot \left(\frac{20.95}{100}\right)</math></p> <p>c. <math>O_2\% = \left(\frac{PPO_2}{BP}\right) 100</math></p>	<p>Please see the <a href="#">Calculating the O<sub>2</sub> Concentration procedure</a> on page 101</p>
<p>2. Verify that the BACTROX-2 has been powered for more than 5 minutes.</p> <p>a. Calibrating with an O<sub>2</sub> sensor that has not warmed up fully will lead to an inaccurate calibration.</p>	 <p>&gt; 5 Minutes</p> 
<p>3. Connect the RS232 DB9 cable to the port on the left side of the BACTROX-2 control panel box.</p> 	<p>RS232 Port</p> 
<p>4. Connect the RS232 DB9 cable to your computer.</p> <p>a. Use the USB adaptor included with the calibration kit if necessary. Remember to download and install the free driver if using the adaptor.</p> 	

## Dual Point O<sub>2</sub> Calibration (Continued)

5. Open the terminal emulator on your computer.
  - a. For Tera Term, select the serial button in the lower left corner of the **New Connection** window.
  - b. If you know the communication port used by your computer, select it in the Port dro-down menu on the lower right side of the New Connection window.
  - c. If you do not know the com port, **select COM1**. The correct port may be determined by process of elimination. See next step (6).
  - d. **Click OK**.



6. Connection: If using Tera Term, the emulator should start logging data from the BACTROX-2 once every minute if the correct com port was chosen. If the emulator is not logging the data, perform the following steps.



- a. Verify that a USB to Serial Adaptor driver has been installed if you are using the RS232 to USB Adaptor
- b. Close Tera Term.
- c. Re-open Tera Term.
- d. Select a different com port.

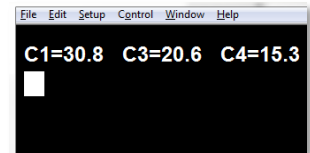

### Logging Channels:

C1 = Current Temperature  
 C3 = Current Oxygen  
 C4 = Current CO<sub>2</sub>

**Note:** The output logging channels and the calibration input channels are completely separate channels, with a separate numbering system.

7. Saving O<sub>2</sub> log data (optional). To save log data from the BACTROX-2 during the calibration, perform the following steps.



- a. Click on the Tera Term File tab.
- b. Click on the "Log" option.
- c. Create a file on your computer to save the log data in.
- d. Click OK after naming the file.
- e. Data will now be saved.

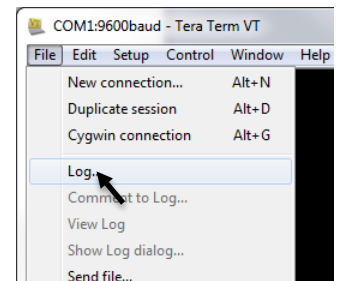

Continued on next page

## Dual Point O<sub>2</sub> Calibration (Continued)



OR



Wait 5 Seconds

8. Set the O<sub>2</sub> set point to OFF. This prevents the BACTROX-2 controller from attempting to adjust the chamber O<sub>2</sub> concentration while the O<sub>2</sub> sensor is isolated from the workspace environment. It also disables the O<sub>2</sub> deviation alarms during the calibration process.

- a. Push and release either the **Up or Down arrow button**. The display will briefly flash the letters SP.
- b. When the display dims and flashes an adjustable set point, press and hold the down arrow button until the display reads "Off".
- c. Wait five (5) seconds for the display to stop flashing.

SET OXYGEN %



SET OXYGEN %



9. Install the O<sub>2</sub> calibration kit sensor cover plate on the oxygen sensor cage.

- a. Tighten the plate thumb screws until finger tight.
- b. This isolates the O<sub>2</sub> sensor and allows a sufficient concentration of calibration sample gas to build up around the sensor head.

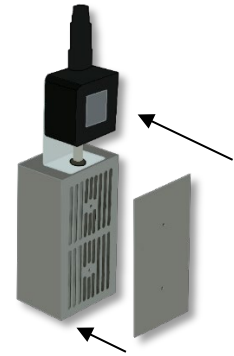

## Upper Value Calibration

10. Attach the upper calibration gas sample to the O<sub>2</sub> CAL PORT.



- a. If you are using **ambient air** for the upper calibration sample, plug the oxygen calibration pump included with the BACTROX-2 into a suitable wall power source. Attach the calibration kit tubing to the pump and then to the O<sub>2</sub> CAL PORT on the BACTROX-2. Push the pump power switch to the ( I ) ON position. The pilot light on the pump will illuminate, and air will be pumped into the O<sub>2</sub> sensor box.

Or



- b. If you are using a **reference gas mixture** for the upper calibration sample, connect the gas cylinder regulator to the O<sub>2</sub> CAL Port on BACTROX-2. Use the tubing provided with the oxygen calibration kit. Set the cylinder regulator to 3 PSI. **Never set the regulator to higher than 3 PSI.** Open the regulator control valve to establish a flow of gas to the sensor.



Procedure continued on next page

## Dual Point O<sub>2</sub> Calibration (Continued)

11. Wait 5 minutes for a sufficient upper calibration O<sub>2</sub> sample concentration to build up in the sealed sensor box.

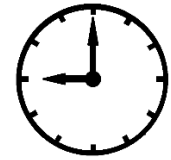

Wait 5 Minutes

12. Access the BACTROX-2 calibration channels using the terminal emulator software on your computer after 5 minutes have elapsed.



- a. Type **BRO=0** in the emulator window and press **Enter**.
- b. You now have access to the calibration channels.

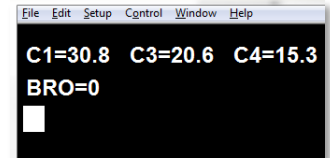

**Note:** The BACTROX-2 will automatically revert out of the calibration channels every three minutes to prevent accidental calibration adjustments from being made.

**Note:** The 20.7% shown to the right is an arbitrary example value.

13. Check the green SET OXYGEN % display on the BACTROX-2.

- a. If the BACTROX-2 O<sub>2</sub> display matches the O<sub>2</sub> concentration of your upper calibration sample, the upper value is now calibrated. Advance to step 16.

**Or**

- b. If there is a difference between the O<sub>2</sub> display reading and the concentration of your sample, and that difference exceeds the range allowed by your laboratory protocol, enter an upper calibration adjustment. **See next step.**

**Upper Sample O<sub>2</sub>% = 20.7%**

SET OXYGEN %



**Or**

SET OXYGEN %



Continued on next page

## Dual Point O<sub>2</sub> Calibration (Continued)

14. Enter an upper calibration adjustment to match the Set Oxygen % display to the upper calibration gas sample value.



a. Enter the air or reference gas concentration into the BACTROX-2 by typing **UC2=sample value** in the emulator window. For example, if your air sample or reference gas has an O<sub>2</sub> concentration of 20.7%, type **UC2=20**, and press **Enter**.

b. The BACTROX-2 display should now match the O<sub>2</sub> concentration of your sample.

**Note:** UC2 indicates the upper calibration value for oxygen  
LC2 indicates the low calibration value for oxygen

Upper Sample O<sub>2</sub>% =  
20.7%

SET OXYGEN %

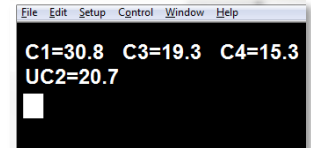

SET OXYGEN %







15. Turn off and unplug the calibration kit air pump, or close the valve of the reference gas cylinder. Set the cylinder regulator to 0. Disconnect the pump or cylinder from the O<sub>2</sub> Cal Port.



Continued on next page

## Low-Value Calibration

Dual Point O <sub>2</sub> Calibration (Continued)	
<p>16. Attach your low-value reference gas mixture to the O<sub>2</sub> Cal Port. <b>Do not use ambient air for the low-value sample.</b></p>  <ol style="list-style-type: none"> <li>a. Set the cylinder regulator to 3 PSI. <b>Do not set the regulator to higher than 3 PSI.</b></li> <li>b. Open the regulator control valve to establish a flow of gas to the sensor.</li> </ol>	
<p>17. Wait 5 five minutes for the low-value reference mix to purge the sensor box and establish a sufficient concentration.</p>	 <p style="text-align: center;">Wait 5 Minutes</p>
<p><b>Note:</b> <i>The 5% shown to the right is an arbitrary example value. The O<sub>2</sub> value of your low-value gas mix should be chosen on the basis of your study or laboratory protocol requirements.</i></p> <p>18. Check the SET OXYGEN % display on the BACTROX-2.</p> <ol style="list-style-type: none"> <li>a. If the display matches the O<sub>2</sub> concentration of the low calibration gas mix, the BACTROX-2 low calibration value is now calibrated. <b>Advance to step 21.</b></li> </ol> <p style="text-align: center;"><b>Or</b></p> <ol style="list-style-type: none"> <li>b. If there is a difference between the display and the reference gas concentration and that difference exceeds the acceptable range of your laboratory or study protocol, enter a low calibration adjustment. <b>See next step.</b></li> </ol>	<p style="text-align: center;"><b>Lower Sample O<sub>2</sub>% = 5.0%</b></p> <p style="text-align: center;">SET OXYGEN %</p>  <p style="text-align: center;"><b>Or</b></p> <p style="text-align: center;">SET OXYGEN %</p> 

Continued on next page



## Dual Point O<sub>2</sub> Calibration (Continued)

19. Enter a low calibration adjustment to match the O<sub>2</sub> sensor and display to the sample concentration value.



- a. Type **BRO=0** in the Tera Term window and press **Enter** to ensure that you are still accessing the calibration channels.
- b. Enter the low calibration gas O<sub>2</sub> concentration by typing **LC2=sample value** in the Tera Term window. For example, if the low calibration reference gas has an O<sub>2</sub> concentration of 5%, **type LC2=5** and hit **Enter**.
- c. The BACTROX-2 display should now match the O<sub>2</sub> concentration value of the low calibration reference gas.

**Note:** LC2 indicates the low calibration value for oxygen.

**Lower Sample**  
O<sub>2</sub>% = 5.0%

SET OXYGEN %

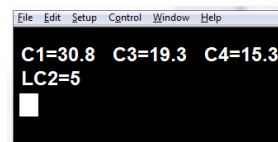

SET OXYGEN %



## Verify Calibration Across Full Range

20. Verify that the sensor is accurate across the full range of the established O<sub>2</sub> curve by rechecking the high calibration accuracy.

- a. Close the valve and set the regulator of the low reference gas cylinder to zero (0). Disconnect the low cylinder from the calibration gas port.
- b. Re-attach your upper calibration sample to the O<sub>2</sub> Cal Port. Plug in and turn on the calibration kit air pump. **Or**, set the upper reference cylinder regulator to 3 PSI, and open the regulator control valve to establish a flow of gas to the sensor.
- c. Wait 5 minutes for the upper calibration sample gas to purge the sensor box and build up a sufficient concentration. Failure to wait for the full 5 minutes will result in an inaccurate calibration.



Wait 5 Minutes

**Low Value**



**Upper Value**



Continued on next page

## Verification of Full Range Continued

### Dual Point O<sub>2</sub> Calibration (Continued)

21. If the BACTROX-2 display matches the O<sub>2</sub> concentration of the upper calibration sample, the dual point calibration is accurate across the range of the curve. Advance to step 23.

- a. If the O<sub>2</sub> concentration does not match the concentration of the air or reference gas sample, **repeat steps 11 – 21** starting on page 70. Recalculate the ambient air O<sub>2</sub> concentration if you are using ambient air for the high calibration.
- b. Contact Sheldon Manufacturing Technical Support for assistance if the high value does not match the ambient air or reference gas concentration after 3 attempts.

**Upper Sample**  
O<sub>2</sub>% = 20.7%  
SET OXYGEN %



Or

SET OXYGEN %

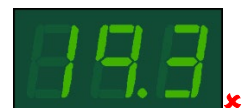

**Repeat steps 10 – 21**

22. Return the unit to normal operation after a successful calibration.

- a. Disconnect the calibration air pump or high calibration gas cylinder.
- b. Reattach the O<sub>2</sub> Cal Port cover cap.
- c. Disconnect the RS232 cable unless you wish to continue logging data from the BACTROX-2.
- d. **Remove the calibration kit cover plate from the oxygen sensor.** Failure to do so will result in inaccurate O<sub>2</sub> readings.
- e. **Set the O<sub>2</sub> concentration** set point (page 38) for your application using the Set Oxygen % arrow buttons.
- f. The oxygen concentration in the workspace chamber may have fallen or risen during the calibration procedure. Monitor the BACTROX-2 and make sure it achieves the set point. Gas injection lights will illuminate as the unit matches and stabilizes at the set point.

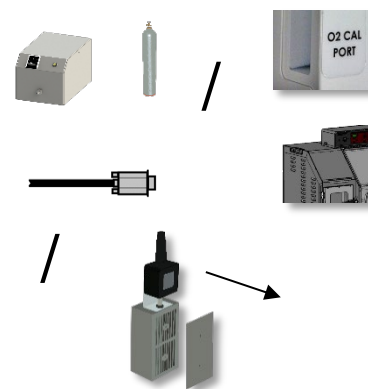
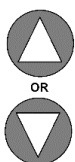

SET OXYGEN %

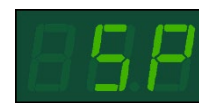





**Your Application**  
O<sub>2</sub>% Set Point

End of dual point calibration

**Note:** Make sure the calibration kit cover plate is inside the workspace chamber prior to starting this process.

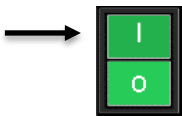
## Single Point O<sub>2</sub> Calibration

A single point calibration is valid for a narrow range centered on the calibration sample value. For example, if the unit is calibrated using a reference gas with 10% O<sub>2</sub>, the calibration is valid for a narrow band around 10%. The manufacturer recommends using a calibration reference gas with an O<sub>2</sub> concentration matching your hypoxic application set point.

Single Point O <sub>2</sub> Calibration	
<ol style="list-style-type: none"> <li>1. Verify that the BACTROX-2 has been powered for more than 5 minutes.                             <ol style="list-style-type: none"> <li>a. Calibrating with an O<sub>2</sub> sensor that has not warmed up fully will lead to an inaccurate calibration.</li> </ol> </li> </ol>	 <p>&gt; 5 Minutes</p> 
<div style="display: flex; align-items: center;">  <div style="margin-left: 10px;"> <ol style="list-style-type: none"> <li>2. Set the O<sub>2</sub> set point to OFF. This prevents the BACTROX-2 controller from attempting to adjust the chamber O<sub>2</sub> concentration while the O<sub>2</sub> sensor is isolated from the workspace environment. It also disables the O<sub>2</sub> deviation alarms during the calibration process.                             <ol style="list-style-type: none"> <li>a. Push and release either the <b>Up or Down arrow button</b>. The display will briefly flash the letters SP.</li> <li>b. When the green Oxygen % display dims and flashes an adjustable set point, press and hold the down arrow button until the display reads "Off".</li> <li>c. Wait 5 seconds for the display to stop flashing.</li> </ol> </li> </ol> </div> </div> <div style="margin-top: 20px;">  <p>Wait 5 Seconds</p> </div>	<p>SET OXYGEN %</p>  <p style="text-align: center;">↓</p> <p>SET OXYGEN %</p> 

Continued on next page

## Single Point O<sub>2</sub> Calibration (Continued)

3. Install the O<sub>2</sub> calibration kit sensor cover plate on the oxygen sensor cage.
  - a. Tighten the plate thumb screws until finger tight.
  - b. This isolates the O<sub>2</sub> sensor and allows a sufficient concentration of calibration sample gas to build up around the sensor head.

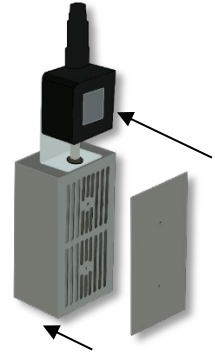

4. Attach the calibration gas sample to the O<sub>2</sub> CAL PORT.



- a. Connect the gas cylinder to the O<sub>2</sub> CAL Port on BACTROX-2.
- b. Use the tubing provided with the oxygen calibration kit. Set the cylinder regulator to 3 PSI.
- c. **Never set the regulator to higher than 3 PSI.** Open the regulator control valve to establish a flow of gas to the sensor.



5. Wait 5 minutes for a sufficient sample concentration to build up in the sealed sensor box.

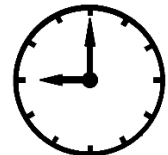

Wait 5 Minutes

Continued on next page

## Single Point O<sub>2</sub> Calibration (Continued)

**Note:** The 15% O<sub>2</sub> sample value and 13.4% display are arbitrary example values.

6. Check the green SET OXYGEN % display.
  - a. If display matches the O<sub>2</sub> concentration of your calibration reference, the BACTROX-2 is now calibrated for O<sub>2</sub>. Advance to step 9.
  - Or**
  - b. If there is a difference between the display reading and the concentration of your sample, and that difference exceeds the range allowed by your laboratory protocol, enter a calibration offset. **See next step.**

**Sample O<sub>2</sub>% = 15%**

SET OXYGEN %  

Or

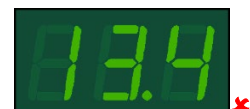
SET OXYGEN %  

7. Place the display in its calibration mode.

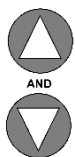

- a. Press and hold both the **UP and DOWN** Set O<sub>2</sub> arrow buttons simultaneously for approximately 5 seconds.
- b. Release the buttons when the display shows the letters "CO". The display will begin flashing the **current O<sub>2</sub> display value**.

**Note:** If an arrow button is not pushed for five seconds, the display will cease flashing, and store the last displayed value as the new current O<sub>2</sub> value.

**Sample O<sub>2</sub>% = 15%**

SET OXYGEN %  

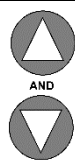
8. Use the **Up** or **Down** arrow buttons to adjust the current O<sub>2</sub> display value until it matches the reference gas O<sub>2</sub> concentration.

SET OXYGEN %  

9. After matching the display to the reference device, wait 5 seconds.



Wait 5 Seconds

- a. The display will cease flashing and store the corrected display value.
- b. The chamber will begin injecting O<sub>2</sub> or allow the current gas concentration to decay in order to achieve the set point with the corrected display value.

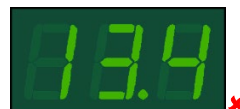
SET OXYGEN %  

Continued on next page

## Single Point O<sub>2</sub> Calibration (Continued)



Wait 1 Hour

10. Allow the BACTROX to sit for at last 1 hour undisturbed to stabilize **after it has achieved the corrected O<sub>2</sub> set point.**

- a. Failure to wait until the unit is fully stabilized will result in an inaccurate reading and calibration.

SET OXYGEN %



11. If the BACTROX-2 display matches the O<sub>2</sub> concentration of the reference gas, the O<sub>2</sub> sensor and display are now calibrated. Advance to step 10.

Or

- a. If the O<sub>2</sub> concentration does not match the concentration of the reference gas sample, **repeat steps 6 - 10** starting on page 78 .

Contact Technical Support for assistance if the display value does not match your sample concentration after 3 attempts.

Sample O<sub>2</sub>% = %

SET OXYGEN %



Or

SET OXYGEN %



Repeat steps 6 – 11

12. Return the unit to normal operation after a successful calibration.

- a. Disconnect the calibration air pump or reference gas cylinder.
- b. Reattach the O<sub>2</sub> Cal Port cover cap.
- c. Remove the calibration kit cover plate from the oxygen sensor.
- d. **Set the O<sub>2</sub> concentration** set point (see page 38) for your application using the Set Oxygen % arrow buttons.
- e. The oxygen concentration in the workspace chamber may have fallen or risen during the calibration procedure. Monitor the BACTROX-2 and make sure it returns to the set point. Gas injection lights will illuminate as the unit matches and stabilizes at the set point.



OR

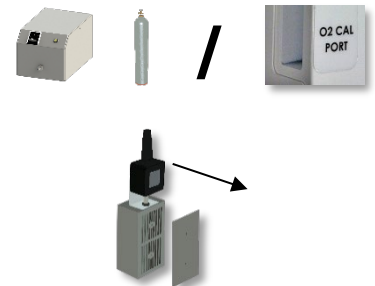

SET OXYGEN %



Your Application O<sub>2</sub>% Set Point

End of procedure

## CALIBRATE THE CO<sub>2</sub> DISPLAY

**Note:** Performing a CO<sub>2</sub> display calibration requires a gas reference device. Please see the [CO<sub>2</sub> Reference Sensor Devices entry](#) on page 10 for the device requirements.



Gas calibrations are performed to match the unit CO<sub>2</sub> display to the actual CO<sub>2</sub> concentration inside the workspace chamber. The actual gas concentration is supplied by a calibrated reference device. Calibrations compensate for long-term drifts in the microprocessor controller as well as those caused by the natural material evolution of the infrared sensor over time. Calibrate as often as required by your laboratory or production protocol or regulatory compliance schedule. Always calibrate to the standards and use the calibration setup required by your industry requirements or laboratory protocol.

A reference gas is not required for a CO<sub>2</sub> calibration.

### A suggested calibration setup

**1.** Connect the reference device sample tubing to **Sample Port** located on the top, left side unit.

**2.** Close the pass box and arm port doors. These must remain closed and sealed during the calibrations to avoid disturbing the CO<sub>2</sub> concentration of the chamber.

**3.** The workspace chamber must be supplied with CO<sub>2</sub> prior to and throughout the calibration procedure. If a CO<sub>2</sub>-enriched atmosphere is not already present in the chamber, start a flow of gas to the chamber and set a CO<sub>2</sub> gas set point.

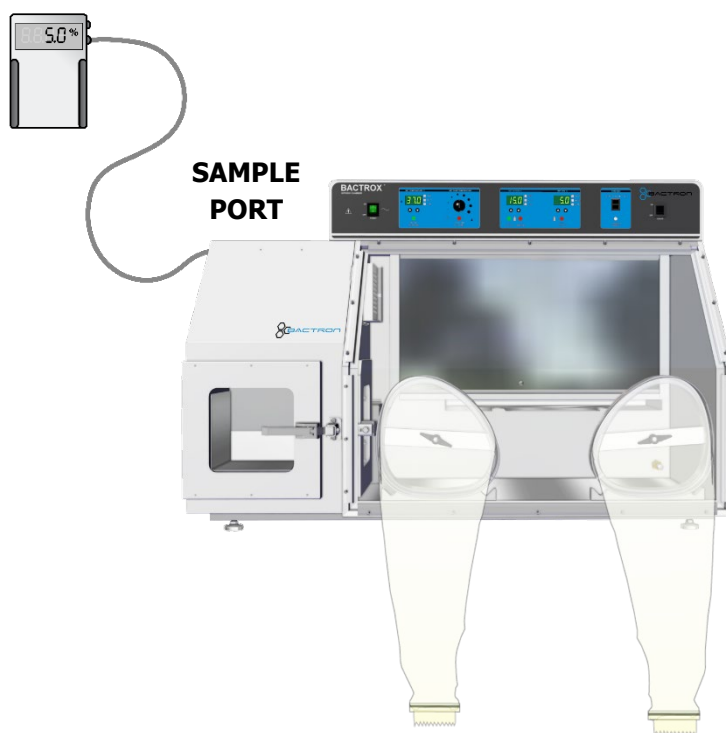

### Prep Times

**12 Hours:** The time the chamber incubator must be running at your application temperature prior to calibrating for CO<sub>2</sub>.

**8 Hours:** The time the workspace chamber must be continually supplied with CO<sub>2</sub> and operating with a set CO<sub>2</sub> set point prior to



# USER MAINTENANCE

## Gas Stabilization

The CO<sub>2</sub> concentration in the chamber must be given time to stabilize in order to perform an accurate calibration.

- Temperature impacts gas diffusion. The unit must be thermally stable with the chamber incubator having operated at your application temperature for **at least 12 hours** prior to starting the gas calibration.
- The unit must be supplied with CO<sub>2</sub> for at least 8 hours prior to beginning the calibration and operate sealed and undisturbed for **at least 1 hour** before calibrating.
- To be considered stabilized, the workspace chamber must operate at the set point gas concentration for **at least 30 minutes with no fluctuations of ±0.1% or greater.**

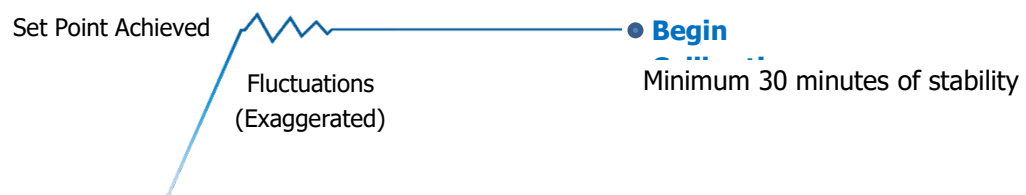

### A Suggested CO<sub>2</sub> Calibration

1

Once the chamber CO<sub>2</sub> concentration has stabilized, compare the reference device and the CO<sub>2</sub> display readings.

- If the readings are the same, or the difference between the two falls within the acceptable range of your protocol, the display is accurately showing the chamber CO<sub>2</sub> concentration. **The CO<sub>2</sub> Calibration procedure is now complete.**

Reference Device

8 5.0 %

Set CO<sub>2</sub> %

5.0 ✓

-OR-

- If a difference falls outside your protocol range, advance to Step 2.

2

A display calibration adjustment must be entered to match the display to the reference device. See next step.

Reference Device

8 5.8 %

5.0 ✗

Continued next page

## CO<sub>2</sub> Calibration Continued

3

Place the chamber CO<sub>2</sub> display in its calibration mode.



- a. Press and hold both the **UP** and **DOWN** temperature arrow buttons simultaneously for approximately 5 seconds.
- b. Release the buttons when the temperature display shows the letters "C O". The display will then begin flashing the current CO<sub>2</sub> display value.



**Note:** If an arrow button is not pressed for five seconds, the display will cease flashing, and store the last displayed number as the CO<sub>2</sub> display value.

4



Use the **Up** and **Down** arrow buttons to adjust the display CO<sub>2</sub> % value until it matches the reference device concentration reading.

Reference Device



5

After matching the display to the reference device, wait 5 seconds.



Wait 5 Seconds

- The gas display will cease flashing and store the corrected chamber display value.
- The chamber will now begin injecting CO<sub>2</sub> or allowing the current concentration to decay in order to achieve the set point with the corrected display value.



Decaying to Set Point

6



Wait 1 Hour

Allow the chamber to sit for at least one 1 hour undisturbed to stabilize **after the chamber has achieved the corrected gas set point.**

- Failure to wait until the chamber is fully stabilized will result in an inaccurate reading.

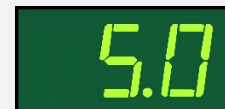

Set Point Achieved

Continued next page

## CO<sub>2</sub> Calibration Continued

7

Compare the reference device reading with the unit CO<sub>2</sub> display again.

- If the reference device and the unit display readings are the same or the difference falls within the range of your protocol, **the unit is now calibrated for CO<sub>2</sub>**.

**-OR-**

- See the next step if the readings fail to match or fall outside of your protocol range.

### Reference Device



8

If the two readings are not the same, and the difference still falls outside the acceptable range of your protocol, repeat steps 3 – 7 up to two more times.

- Three calibration attempts may be required to successfully calibrate units that are more than  $\pm 2\%$  out of calibration.

### Reference Device

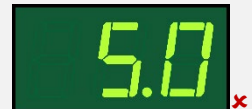

9

Contact your distributor or technical support for assistance if the gas concentration readings of the unit CO<sub>2</sub> display and the reference device still fall outside your protocol after 3 attempts.

End of procedure

## CALIBRATE THE TEMPERATURE DISPLAY

**Note:** Performing a temperature display calibration requires a temperature reference device. Please see the [Temperature Reference Sensor Device entry](#) on page 11 for the device requirements.



Temperature calibrations are performed to match an incubator temperature display to the actual air temperature inside the incubator. The actual air temperature is supplied by a calibrated reference device. Calibrations compensate for long-term drifts in the BACTROX-2 microprocessor controller as well as those caused by the natural material evolution of the sensor probe in the heated incubation space. Calibrate as often as required by your laboratory or production protocol, or regulatory compliance schedule. Always calibrate to the standards and use the calibration setup required by your industry requirements or laboratory protocol.

### Suggested Calibration Setup

1. Introduce the reference sensor device into the workspace chamber through the pass box.
2. Introduce the sensor thermocouple probe into the incubator through the side of one of the incubator doors.

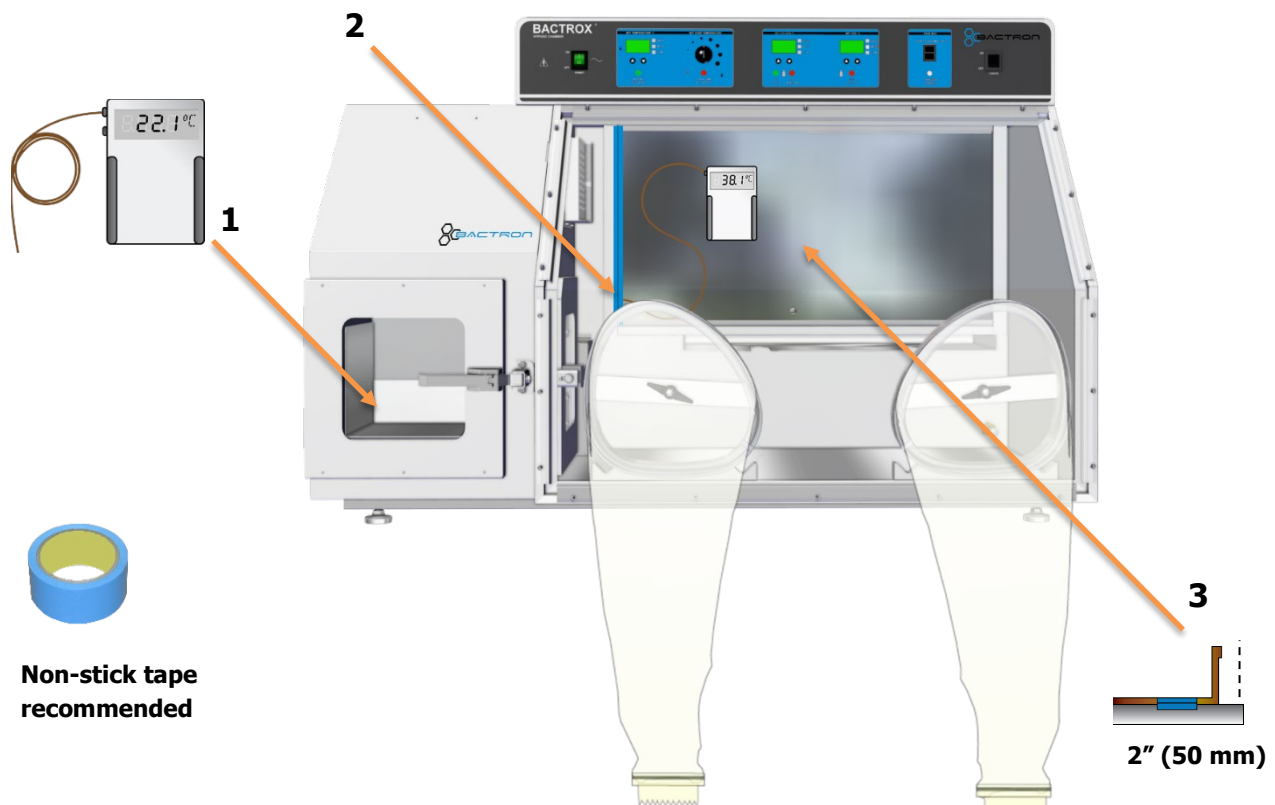

**Non-stick tape recommended**

**3.** Position the thermocouple probe head as near as possible to the geometric center of the chamber. The head be at least 2 inches (50 mm) from the shelf surface to prevent heatsinking. Secure the thermocouple probe to the shelving with non-marking tape.

**4.** Close the incubator doors. Seal any gaps along the side of the doors using non-stick tape. **Do not seal the finger holes on the doors.**

## Temperature Stabilization

The incubator air temperature must stabilize in order to perform an accurate calibration.

- Allow the incubator to operate undisturbed with the doors shut for **at least 24-hours** when first putting the BACTROX into operation in a new environment.
- Operating **8-hours** undisturbed with the doors shut will suffice for a BACTROX that has been in operation for at least 1 day.
- To be considered stabilized, the incubator must operate at your calibration temperature for **at least 1 hour with no fluctuations of  $\pm 0.2^{\circ}\text{C}$  or greater.**

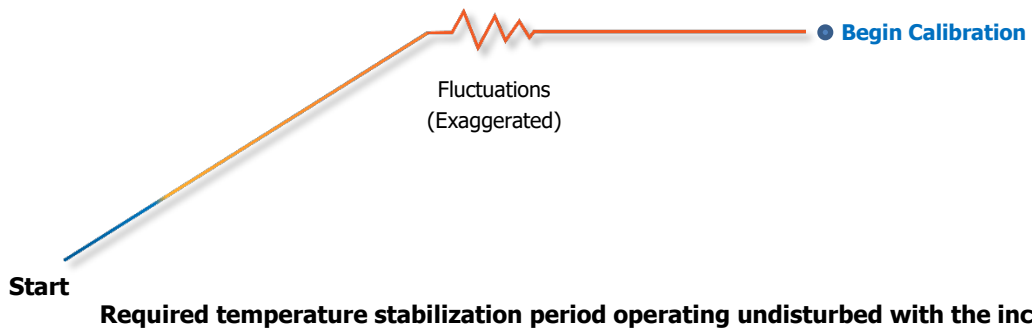

### Suggested Temperature Calibration

1

Once the incubator temperature has stabilized, compare the reference device and incubator temperature display readings.

- If the readings are the same, or the difference between the two (2) falls within the acceptable range of your protocol, the display is accurately showing the incubator air temperature. **The Temperature Calibration procedure is now complete.**

Reference Device

37.0 °C

37.0 ✓

- Or -

- If a difference falls outside of your protocol range, advance to step 2.

2

A display calibration adjustment must be entered to match the display to the reference device. See next step.

Reference Device

38.1 °C

37.0 ✗

Continued next page

## Temperature Calibration Continued

3

Place the display in its temperature calibration mode.



- a. Press and hold both the **UP and DOWN** temperature arrow buttons simultaneously for approximately 5 seconds.



- b. Release the buttons when the temperature display shows the letters "C O". The display will begin flashing the **current temperature display value**.



**Note:** If an arrow button is not pushed for 5 seconds, the display will cease flashing, and store the last displayed number as the new current chamber temperature value.

4



Use the **Up** or **Down** arrow buttons to adjust the current display temperature value until it matches the reference device temperature reading.



Reference Device



5

After matching the display to the reference device, wait 5 seconds.



Wait 5 Seconds

- The temperature display will cease flashing and store the corrected chamber display value.
- The incubator will now begin heating or passively cooling in order to reach the set point with the corrected display value.



Cooling to Set Point

6



Wait 1 Hour

**After** the incubator has achieved the corrected temperature, allow the BACTROX to sit at least 1 hour undisturbed to stabilize.

- Failure to wait until the incubator is fully stabilized will result in an inaccurate reading.



Set Point Achieved

Continued next page

7

Compare the reference device reading with the chamber temperature display again.

- If the reference device and the chamber temperature display readings are the same or the difference falls within the range of your protocol, **the incubator is now calibrated for temperature.**

- OR -

- See the next step if the readings fail to match or fall outside of your protocol range.

Reference Device

A digital display showing the number 37.0 followed by a degree Celsius symbol (°C). The display is white on a grey background.A digital display showing the number 37.0. The display is green on a black background. A small blue checkmark is visible to the right of the display.

8

If the two readings are not the same, and the difference still falls outside the acceptable range of your protocol, repeat steps 3 – 7 up to two more times.

Three calibration attempts may be required to successfully calibrate units that are more than  $\pm 2^{\circ}\text{C}$  out of calibration.

Reference Device

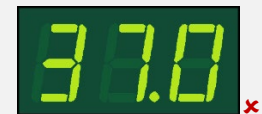
A digital display showing the number 37.4 followed by a degree Celsius symbol (°C). The display is white on a grey background.A digital display showing the number 37.0. The display is green on a black background. A small red X is visible to the right of the display.

9

If the temperature readings of the incubator temperature display and the reference device still fall outside your protocol after 3 calibration attempts, contact your BACTROX distributor or **Technical Support** for assistance.

End of procedure



# UNIT SPECIFICATIONS

These units are 220 – 240 volt units. Please refer to the unit data plate for individual electrical specifications.

Technical data specified applies to units with standard equipment at an ambient temperature of 25°C (77°F) and nominal voltage. The temperatures specified are determined in accordance with factory standard following DIN 12880 respecting the recommended wall clearances of 10% of the height, width, and depth of the inner chamber. All indications are average values, typical for units produced in the series. We reserve the right to alter technical specifications at all times.

## *WEIGHT*

Shipping Weight	Unit Weight
480 lb / 218 kg	304.0 lb / 138.0 kg

## *UNIT DIMENSIONS*

### **By Inches**

Exterior W × D × H	Workspace Chamber W × D × H
49.0 x 32.0 x 33.5 in	33.0 x 28.9 x 25.0 in

### **By Millimeters**

Exterior W × D × H	Workspace Chamber W × D × H
1245 x 813 x 851 mm	838 x 734 x 635 mm

## *STAND DIMENSIONS*

*Optional Stand Available for Purchase*

Inches W × D × H	Millimeters W × D × H
49 x 30 x 30 in	1245 x 762 x 762 mm

# UNIT SPECIFICATIONS

## PASS BOX CAPACITY

### Interior Dimensions

Inches W × D × H	Millimeters W × D × H
9.0 x 10.7 x 9.0 in	229 x 272 x 229 mm

### Pass Box Volume

Cubic Feet	Liters
0.7	20.6

### Total Plate Capacity

Plates
78

## WORKSPACE CAPACITY

### Workspace Chamber Volume

Cubic Feet	Liters
12.5	354

### Workspace Incubator Volume

Cubic Feet	Liters
1.8	50.9

### Workspace Chamber Incubator Interior

Inches W × D × H	Millimeters W × D × H
27.5 x 8.5 x 13.5	699 x 216 x 343

## *INCUBATOR TEMPERATURE*

<b>Range</b>	<b>Uniformity</b>	<b>Stability</b>
Ambient +5°C to 70°C	±1.0°C @ 37°C	±0.2°C @ 37°C

## *INCUBATOR CAPACITY*

<b>Maximum Plates</b>
300

## *GAS RANGES*















<b>O<sub>2</sub> Concentration</b>	<b>CO<sub>2</sub> Concentration</b>
0.5 – 20%	1 – 20%

## *POWER*

<b>AC Voltage</b>	<b>Amperage</b>	<b>Frequency</b>
220 – 240	2	50/60 Hz



# PARTS LIST

Description	Parts Number	Description	Parts Number
<b>Arm Port Door Left</b>	 <b>9900699</b>	<b>Gas Tubing</b> black, ¼ inch OD, 1 foot in length. Order by feet for an unbroken length.	 <b>8500516</b>
<b>Arm Port Door Right</b>	 <b>9900698</b>	<b>Leveling Foot</b>	 <b>2700506</b>
<b>Arm Port Door O-Ring</b>	 <b>6000509</b>	<b>Pass Box Door Gasket, 1 Each</b> 9 inches x 9 inches (burgundy)	 <b>3450506</b>
<b>Calibration Ambient Air Sample Pump</b>	 <b>9490573</b>	<b>Petri Dish Rack, 2 stacks</b> of 11 Petri plates (for workspace incubators)	 <b>5110729</b>
<b>Calibration Kit Cover</b>	 <b>9490570</b>	<b>Power Cord, 250V, 10 Amp, EU 1-16P, CEE7/7, 8 feet (2.5m), detachable</b>	 <b>1800500</b>
<b>Fuse 4A 5 X 20 Type T</b> Slow Blow, Fuse Inlet. Requires 2 fuses,	 <b>3300537</b>	<b>Shelf Spacer, Incubator</b>	 <b>5680502</b>
<b>Gas Regulator, CO<sub>2</sub></b> Includes 16 feet of ¼ inch OD connection tubing.	 <b>9740558</b>		
<b>Gas Regulator Inert Gas, (Nitrogen).</b> Includes 16 feet of ¼ inch OD connection tubing.	 <b>9740546</b>		



# PARTS

## Sleeves and Sleeve Components

Description	Parts Number	Description	Parts Number
<b>Sleeve Cuff Plug,</b> 1 each	 <b>7200502</b>	<b>Sleeve Cuffs Latex, Size 6.5</b> (for extra small sleeve assembly)	 <b>9990774</b>
<b>Sleeve Assembly Size 6.5,</b> Extra Small (2 cuffs, 2 cuff-rings, 4 O-rings, 2 sleeve bodies, 2 self-gripping straps)	 <b>9990738XS</b>	<b>Sleeve Cuffs Latex, Size 7</b> (for Small sleeve assembly)	 <b>3600500</b>
<b>Sleeve Assembly Size 7,</b> Small (2 cuffs, 2 cuff-rings, 4 O-rings, 2 sleeve bodies, 2 self-gripping straps)	 <b>9990738S</b>	<b>Sleeve Cuffs Latex, Size 8</b> (for Medium sleeve assembly)	 <b>3600501</b>
<b>Sleeve Assembly Size 8,</b> Medium (2 cuffs, 2 cuff-rings, 4 O-rings, 2 sleeve bodies, 2 self-gripping straps)	 <b>9990738M</b>	<b>Sleeve Cuffs Latex, Size 9</b> (for Large sleeve assembly)	 <b>3600502</b>
<b>Sleeve Assembly Size 9,</b> Large (2 cuffs, 2 cuff-rings, 4 O-rings, 2 sleeve bodies, 2 self-gripping straps)	 <b>9990738L</b>	<b>Sleeve Cuffs Nitrile, Size 7</b> (for Small sleeve assembly)	 <b>3600525</b>
<b>Sleeve Cuff-Ring 4 Inches,</b> interior diameter (for Small, Medium and Large)	 <b>6400590</b>	<b>Sleeve Cuffs Nitrile, Size 8</b> (for Medium sleeve assembly)	 <b>3600526</b>
<b>Sleeve Cuff O-Ring, Black, 4 Inches</b> (For the 4-inch Sleeve Cuff Ring. Two O-rings are required).	 <b>6000504</b>	<b>Sleeve Cuffs Nitrile, Size 9</b> (for Large sleeve assembly)	 <b>3600527</b>
<b>Sleeve Cuff-Ring 3.5 Inches,</b> interior diameter (for extra-small sleeve assembly)	 <b>6400619</b>	<b>Sleeve, Extra Small (10in to 3.5in diameter)</b> (for XS sleeve assembly)	 <b>9990775</b>
<b>Sleeve Cuff O-Ring, 3.5 inches,</b> (For extra-small sleeve assembly. Only one is required.)	 <b>6000503</b>	<b>Sleeve, Standard (10in to 4.0in dia.)</b> (for S, M, L sleeve assemblies)	 <b>3600521</b>





## Ordering

Accessories and replacement parts can be ordered online at [parts.sheldonmfg.com](http://parts.sheldonmfg.com).

If the required item is not listed online, or if you require assistance in determining which part or accessory you need contact Sheldon Manufacturing by emailing [parts@sheldonmfg.com](mailto:parts@sheldonmfg.com) or by calling 1-800-322-4897 ext. 4 or (503) 640-3000 ext. 4.

Please have the **model**, **serial**, and **part** numbers of the unit ready. Tech Support needs this information to match your unit to its correct part.



# ACCESSORIES

Shel Lab offers the following BACTROX accessories for sale. Please see our website for prices.

## Activated Carbon Media (2 lb / 0.9 kgs)

For scrubbing hydrogen sulfides, fatty acids, and some toxic or corrosive compounds from the chamber atmosphere.

Part Number 1060500



## Activated Carbon, Volatile Compounds Scrubber Fan

Holds activated carbon scrubber media. Significantly speeds the removal of sulfides, fatty acids, and toxic or corrosive compounds.

Part Number 9490581 (For 220 - 230 volt units)



## Acrylic Glass Cleaner (2oz / 59.2ml)

Novus brand acrylic glass cleaner.

Part Number 1060503



## Acrylic Glass Scratch Remover (2oz / 59.2ml)

Helps remove visible scratches and nicks from acrylic glass.

Part Number 1060504

Part Number 1060500.



## Compressed Gas Cylinder Switcher, Automatic

Allows two gas cylinders to be connected to one gas port, and automatically switches from the first to the second cylinder when the first is empty.

Part Number 2002-B2E



## **BACTROX Rolling Stand**

A caster-mounted stand for the BACTROXEZ

48.1 inches wide, 30 inches deep, 29.3 inches high

(1222 mm wide, 762 mm deep, 744 mm high)

Part Number: BACSTAND-SM22



## **Lukas Fiber Optic Micro Lite Illumination System**

A fiber optic, adjustable brightness, halogen light box and guide. Provides a stable light for use with BACTROX chambers and stereo microscopes.

Part Number 4650503



## **UV Viewing Lamp**

A handheld UV lamp for use with BACTROX chambers.

Parts Number 9490507



## **Zephiran Benzalkonium Chloride Chamber Cleaner**

1 Gallon, 0.133%.

Part Number 1060501



---

**Note:** It is not necessary to calculate the O<sub>2</sub> concentration of the laboratory atmosphere if you will be using O<sub>2</sub> reference gas mixes for calibration. Calculating the ambient O<sub>2</sub>% is only required when calibrating to an ambient atmosphere sample.

---

## *CALCULATING THE O<sub>2</sub> CONCENTRATION*

To determine the oxygen concentration of the ambient laboratory atmosphere, it is necessary to find the partial pressure of the oxygen (PPO) in the atmosphere. To calculate the PPO, it's first necessary to calculate the water vapor pressure (WVP) and then subtract it from the current barometric pressure.

### Calculations

1. Water Vapor Pressure in millibars (mbar)
2. Partial Pressure O<sub>2</sub> in millibars (mbar)
3. O<sub>2</sub> Concentration (%)

### **1) Water Vapor Pressure (WVP) in mbars**

$$WVP = \left( \frac{H_{rel}}{100} \right) \cdot WVP_{max}$$

Calculating the Water Vapor Pressure requires:

- **Relative Humidity (H<sub>rel</sub>)** of the laboratory ambient atmosphere
  - The relative humidity of the laboratory atmosphere can be obtained using a variety of commercially available handheld or desktop sensors. The sensor should provide a relative humidity value accurate to ±1%.
- **Temperature** of the laboratory atmosphere
  - Temperature is used to look up the Water Vapor Pressure Max (WVP<sub>max</sub>). The thermometer device should measure the temperature of the airspace near the BACTROX. **Do not use** the room's climate control thermostat setting or display reading for this value. Both may vary significantly from the air temperature around the BACTROX.
- **Water Vapor Pressure Maximum (WVP<sub>max</sub>)**
  - Please see the WVP<sub>max</sub> table on the next page to find Water Vapor Pressure Max for your current air temperature.

---

**Note:** Never use a relative humidity value taken from outside the room the BACTROX is located in. Use of relative humidity from another room or a weather report will result in an inaccurate O<sub>2</sub> sensor calibration.

---

## Water Vapor Pressure Max ( $WVP_{max}$ )<sup>1</sup>

Temperature (C°)	$WVP_{max}$ (mbar)
15	17.06
16	18.19
17	19.38
18	20.65
19	21.98
20	23.39
21	24.88
22	26.45
23	28.10
24	29.85
25	31.69
26	33.62
27	35.66
28	37.81
29	40.07
30	42.44

## 2) Calculating the $PPO_2$ in mbars

After calculating the WVP value, calculate the Partial Pressure Oxygen for the laboratory environment.

$$PPO_2 = (BP - WVP) \cdot \left(\frac{20.95}{100}\right)$$

Calculating the  $PPO_2$  requires:

- **Water Vapor Pressure**
  - The WVP value calculated in step 1 on the previous page
- **Barometric Pressure (BP) in millibars (mbars)**
  - The current Barometric Pressure for your area can be obtained from a local metrological station or online weather service. If the BACTROX is located in an overpressure or negative pressure laboratory environment, it will be necessary to obtain a barometric pressure sensor to determine the BP value for the room.

<sup>1</sup> Courtesy of NOAA ([http://www.srh.noaa.gov/epz/?n=wxcalc\\_vaporpressure](http://www.srh.noaa.gov/epz/?n=wxcalc_vaporpressure))

### 3) Calculating the O<sub>2</sub> Concentration (%)

$$O_2\% = \left( \frac{PPO_2}{BP} \right) 100$$

Calculating the O<sub>2</sub> concentration requires:

- **PPO<sub>2</sub>**
  - The Partial Pressure Oxygen value calculated in step 2 on the previous page.
- **Barometric Pressure (BP) in millibars (mbars)**
  - The same value previously used to calculate the PPO<sub>2</sub> value.



**SHELDON**  
MANUFACTURING, INC.

P.O. Box 627  
Cornelius, OR 97113  
USA

[support@sheldonmfg.com](mailto:support@sheldonmfg.com)  
[sheldonmanufacturing.com](http://sheldonmanufacturing.com)

1-800-322-4897  
(503) 640-3000  
FAX: 503 640-1366